

**CORE RANGE**

Ask about our local custom solutions

# LUBRICATION SOLUTIONS FOR INDUSTRY



**BECHEM**  
LUBRICATION  
TECHNOLOGY



## Erratum

Due to a technical error in prepress, the chapter „Cooling lubricants for metal cutting“ (pages 82-91) unfortunately contains incorrect information in the columns „Amine free“ and „Performance additives“. To a large extent, you can also view the information on performance additives/lubricant performance and amine content on our homepage and refer to the current technical data sheets. If you have any questions, please contact your BECHEM sales partner.

The cleaner Beruclean 5005 on page 111 is only suitable for steel and grey cast iron and not for non-ferrous metals and aluminium.

Please excuse these errors and understand that the catalogue does not replace advice by our technical sales staff and that we are not liable for any damage arising from the use of the information contained in the catalogue.

**CARL BECHEM GMBH** · Weststr. 120 · 58089 Hagen · Germany  
Telephone +49 2331 935-0 · Fax +49 2331 935-1199 · [bechem@bechem.de](mailto:bechem@bechem.de) · [www.bechem.com](http://www.bechem.com)

---

V2018-01



This catalogue features the BECHEM core range. Inquire with your contact for country-specific lubrication solutions.

For pictograms see inside back cover.

Biodegradable lubricants are marked with  .

All indications and values correspond to latest knowledge and do not represent any product specification.



**BECHEM**  
LUBRICATION  
TECHNOLOGY

# BECHEM – your brand for special lubricants.

BECHEM develops and manufactures premium, high-performance lubricants, coating systems and speciality chemical products developed in collaboration with researchers and product users. The target of our products are to optimize the mechanism or process to maximize value to our customers. We do this with innovative solutions that are for today and tomorrow's challenges. Examples are our microcapsule-based antifriction coatings or

innovative, water-based lubricants that present an alternative to mineral oil-based products.

As a leader in lubrication technology, we engineer and support our customers. So they can be successful. With experienced, dedicated employees, original products, defined core competencies and a consistently high product quality, we are a driving force on the market.



# Content

## **Lubricating greases**

Page 16–44

---

## **Lubricating oils**

Page 46–64

---

## **Pastes**

Page 66–69

---

## **Sprays**

Page 70–74

---

## **Anti-friction coatings**

Page 76–79

---

## **Coolants for metal removal operations**

Page 80–91

---

## **Process media for forming technology**

Page 92–106

---

## **Cleaners**

Page 108–111

---

## **Corrosion protection**

Page 112–115

---

## **Technical information**

Page 116–131

---

## **Tables /diagrams**

Page 132–137

---

## **Product index /Glossary /Keyword index**

Page 138–145



## We are specialized in specialities.

We have written lubrication history for 185 years. In establishing the first German oil factory, Carl Bechem, visionary, creative thinker and entrepreneurial mastermind, laid the foundation for BECHEM's presence across the globe as a leading manufacturer of premium speciality lubricants in 1834. Today, the BECHEM brand is

still family-run, now in its sixth generation. Just how the founder would have wanted it.

As a successful SME, BECHEM prevails against major industrial corporations by focussing on core areas and niches. We consider ourselves as a industrial development partner and

problem-solver. We service a wide range of markets, such as machining and forming, heavy industry, automobiles, food, and pharmaceuticals.

Thanks to our expertise in tailored, innovative ideas and specialities, we will continue developing groundbreaking innovations in the future.

BECHEM headquarters in Hagen, Germany



Besides our main factory in Hagen, we also have additional production sites in Mieste and Kierspe, Germany. Our international production sites are located in China, India and the U.S. Thanks to a sales network with over 70 locations, we deliver to over 80 countries.

Our products are used all over the world in a wide range of industries and we offer the right comprehensive technical service as needed.



BECHEM factory in Liaoning, China



BECHEM factory in Bangalore, India

# We are lubrication experts with industrial solutions from A to Z.

For a broad spectrum of sectors, we solve ultra-complex tribology challenges all over the world with our lubrication solutions and comprehensive technical service. We know our customers and their requirements, and are already working on the challenges of tomorrow today.

- **Agriculture and forestry**
- **Automotive**
- **Cement**
- **Chemicals**
- **Construction**
- **Conveyor technology**
- **Electrical engineering/ electronics**
- **Environmental technology**
- **Fittings**
- **Foods**
- **Mechanical engineering**
- **Metal production and processing**
- **Mining**
- **Paper**
- **Pharmaceuticals**
- **Plant construction**
- **Plastics**
- **Plumbing**
- **Railway**
- **Rubbers**
- **Shipbuilding**
- **Steel**
- **Surface mining**
- **Textiles**
- **Timber**







# We are present across the globe.

Thanks to our subsidiaries, joint ventures and sales partners, we supply virtually the entire world.

With our many locations, we are at your side with comprehensive services and provide you with sup-

port in solving your tribology-related challenges.



An overview of all sales partners:  
**[www.bechem.com](http://www.bechem.com)**

**CARL BECHEM France Sàrl**  
13, Avenue de l'Europe  
67300 Strasbourg-Schiltigheim  
France  
Phone: +33 3 90208421  
[bechem@bechem.fr](mailto:bechem@bechem.fr)

**BECHEM Lubrication  
Technology, LLC**  
8401 Chagrin Road, Suite 5A  
Chagrin Falls, Ohio 44023  
USA  
Phone: +1 440 5616001  
[america@bechem.com](mailto:america@bechem.com)

**CARL BECHEM MÉXICO**  
Lubrication Technology  
S. de R.L. de C.V.  
Prol. Bernardo Quintana Sur No. 302  
Col. Centro Sur, CP 76090 Querétaro  
Mexico  
Phone: +52 442 478 4139  
[bechem@bechem.mx](mailto:bechem@bechem.mx)

**BECHEM COGELSA Iberia S.L.**  
C/ Comercio 36, P. I. Can Sunyer  
08740 Sant Andreu de la Barca  
Barcelona  
Spain  
Phone: +34 93 6822220  
[info@bechem-cogelsa.com](mailto:info@bechem-cogelsa.com)

-  HEADQUARTERS
-  SUBSIDIARIES/JOINT VENTURES
-  DISTRIBUTION PARTNER



**Headquarters Germany**

**CARL BECHEM GMBH**

Weststraße 120, 58089 Hagen  
Germany  
Phone: +49 2331 935-0  
bechem@bechem.de

**CARL BECHEM Scandinavia AB**

Hammargatan 11, 352 46 Växjö  
Sweden  
Phone: +46 470 329400  
post@bechem.eu

**CARL BECHEM GMBH**

**Russia and CIS Representative Office**

Komsomolskaya Ulitsa, 1  
142100 Podolsk, Moscow Region  
Russian Federation  
Phone: +7 926 7630000  
lashkov@bechem.ru

**CARL BECHEM Lubricants  
(Liaoning) Co., Ltd.**

No. 3 Binhe Industrial Area  
117004 Benxi, Liaoning  
China  
Phone: +86 24 45859400  
bechem@bechemchina.com

**BECHEM Lubrication Technology  
(Shanghai) Co., Ltd.**

43/F., Maxdo Centre, 8 Xingyi Road  
Changning District, Shanghai  
China  
Phone: +86 (21) 2231 3063  
sun@bechem.com.cn

**CARL BECHEM Ultra-Lub  
Chemicals (Zhongshan) Co., Ltd.**

No.18. Chongzhan Road  
Shalang West District, Zhongshan City  
528411 Guangdong  
China  
Phone: +86 760 88550808  
l830120@ms10.hinet.net

**CARL BECHEM Switzerland AG**

Wagenhauserstrasse 20  
8260 Stein am Rhein  
Switzerland  
Phone: +41 52 74202-52  
info@bechem.ch

**CARL BECHEM Africa (PTY) Ltd.**

8 Chrome Street  
1910 Vanderbijlpark, Gauteng  
South Africa  
Phone: +27 16 9811016/7  
bechem@bechem.co.za

**CARL BECHEM Lubricants (India)  
Private Limited**

#28D, Bidadi Industrial Area  
Bidadi – Harohalli Main Road  
Ramanagara, Bengaluru 562109  
India  
Phone: +91 80 66900800  
info@bechemindia.com

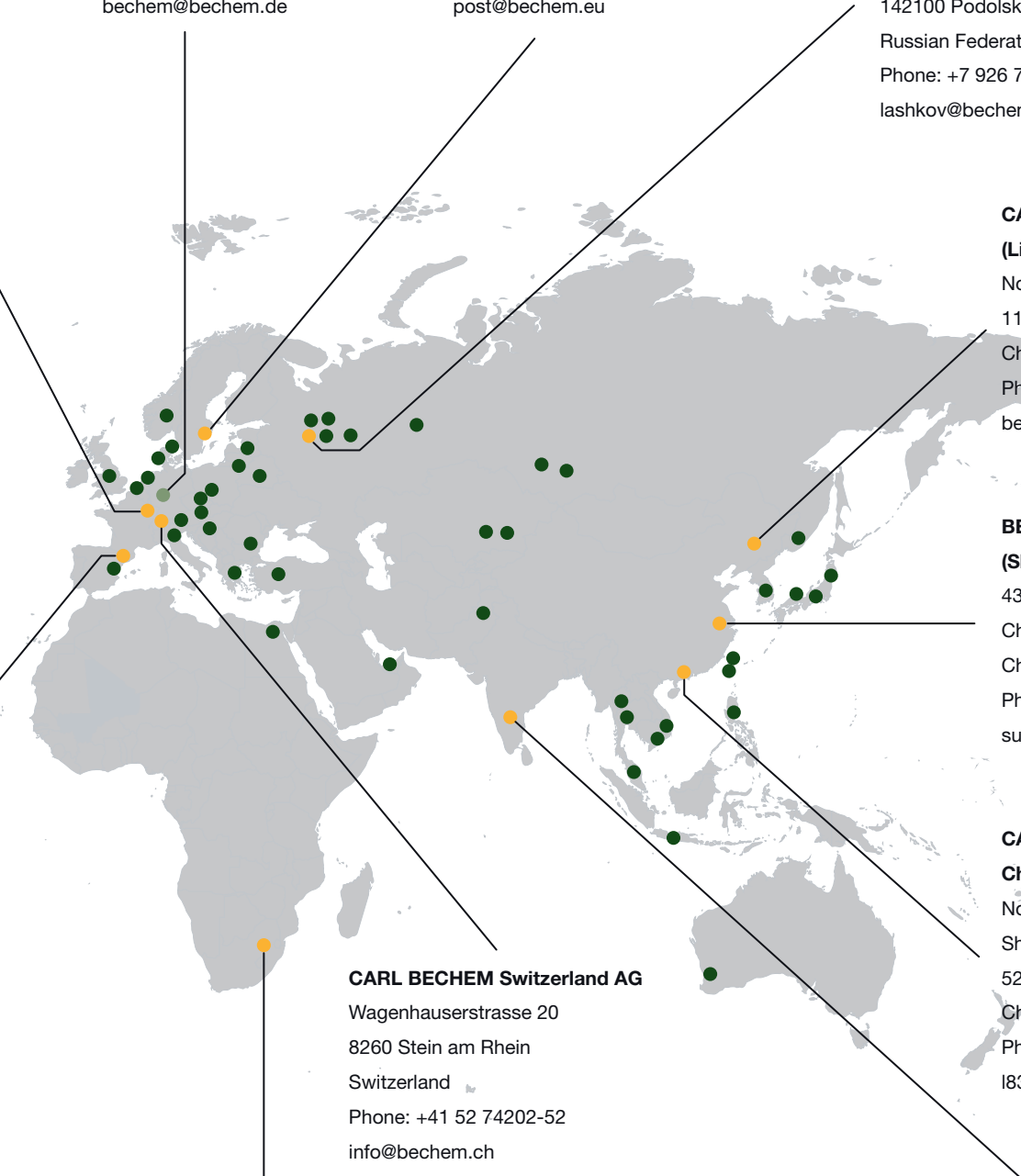

# We live for innovation.



## **Viscous water replaces oil as a coolant**

With the water-based, mineral-oil free Berufluid\* coolant concept, BECHEM has created a completely new, high-quality coolant category besides the conventional water-miscible and non water-miscible metal working fluids, which allows sustainable and more energy-efficient production and presents a solution answer to raw material scarcity in the future.

\* Berufluid – has been awarded the German Raw Material Efficiency Prize, a joint project of BECHEM, Fraunhofer Institute for Process Engineering and Packaging, and Institute of Machine Tools and Production Engineering (TU Braunschweig); © BGR Hannover



## **Phosphate-free wire coating**

With the coating lubricants of the Beruforge 150 series, BECHEM offers a real alternative to phosphatisation in wire coating. The reduction of production steps results in a more environmentally friendly, energy-efficient and cost-saving manufacture.



## **Leading in motor piston coating technology**

With ultra-resilient, durable products, BECHEM equips a major premium manufacturer of motor pistons.



### **Fluid lubricants allow efficient dry lubrication**

BECHEM is a leading provider of anti-friction coatings and a recognized development partner to a wide range of industrial customers. BECHEM was the first company to manufacture anti-friction coatings with microcapsule technology in series production and offers tailored coating products featuring microcapsules filled with active substances.



### **Emulsion technology in aluminium wire drawing**

In aluminium wire drawing, BECHEM Unopol AL has introduced a new era and allows the use of emulsions even in rod wire drawing. The product convinces by superior finished products and cleaner working areas.



### **Tech Days and Innovation Days**

BECHEM's expertise makes the company an esteemed partner at many tech days and innovation days held by major manufacturers, allowing BECHEM to help shape the future.

# We develop solutions.

With our expertise in tailored lubricants, we act as research and development partners to various industries. Together, we realize modern, ground-breaking solutions that are constantly put to the test, developed and adapted to changing requirements.

To ensure top performance in the BECHEM labs for our customers, we invest in our employees, and in state-of-the-art physicochemical testing equipment and analysis tools.

“Made by BECHEM stands for reliable and modern speciality lubricants that exceed performance requirements.”



Testing at the CARL BECHEM Lubricants India lab: Worked penetration indicates the consistency of lubrication greases.

We offer customer-specific lab tests.



Locking pen test rig, specially developed for the testing requirements of an industrial partner.

Close cooperation with research institutes, industry partners and product users as well as the knowledge, skills and major commitment of our staff are guarantees for new and innovative high-performance lubricants. With the extended lifetime of components, machines and tools they considerably contribute to the success of our customers.

A strong network of distributors and several national and international production sites guarantee permanent technical support and ensure that our products are readily available worldwide.

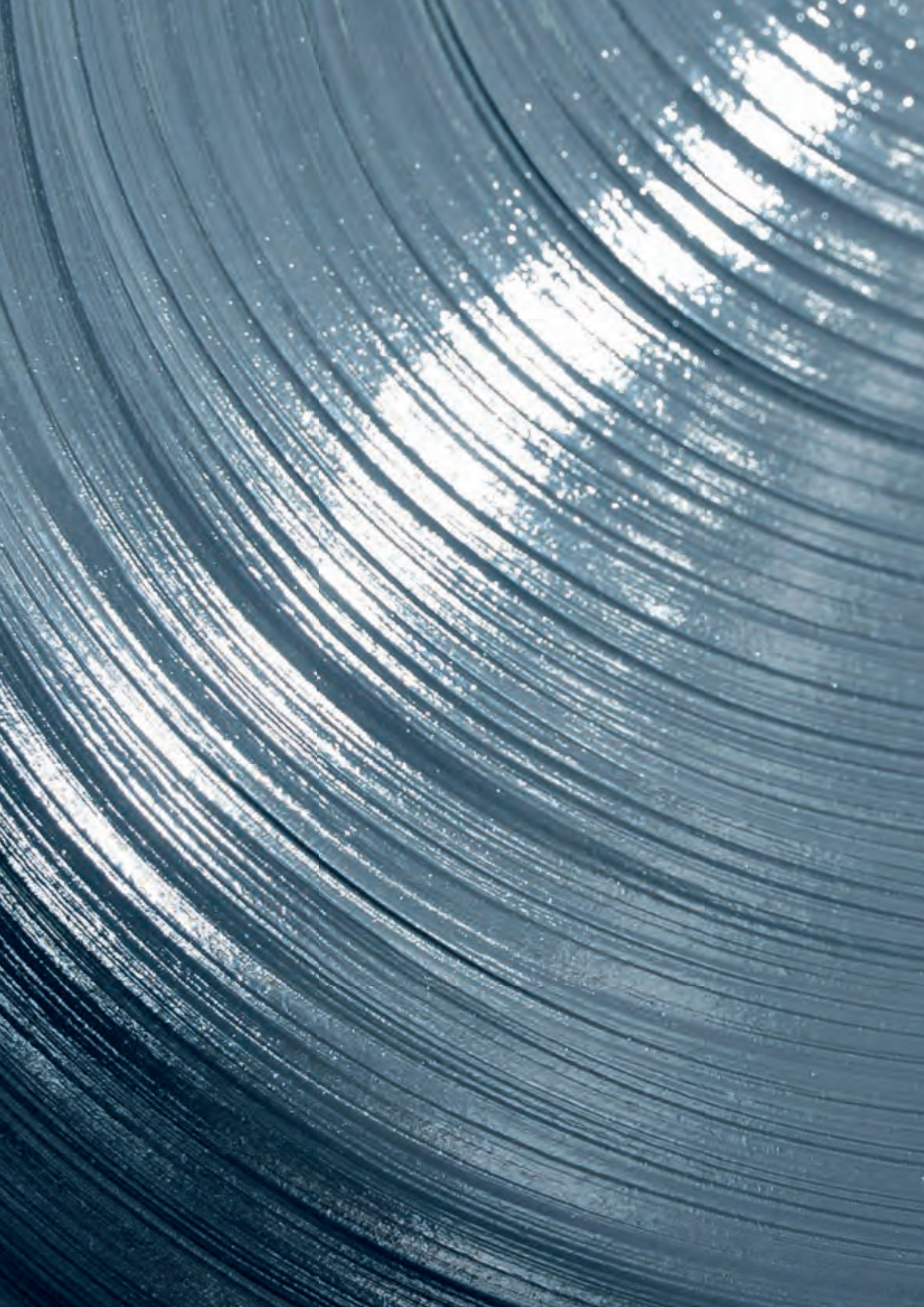



# Lubricating greases

BEICHEM develops and produces high-performance greases for various industrial applications and extreme requirements. BEICHEM offers a wide range of lubricating greases for roller bearings, gears, plastic and electronic components. The applications range from rough conditions in the heavy industry to demanding applications in automotive technology and aeronautics.

According to latest knowledge in tribology, the product range complies with our customers' demands with regard to friction, wear and lubrication as well as economic and ecologic optimisation of the processes themselves.

- **Lubricating greases for roller and plain bearings**
- **Lubricating greases for open and closed gears**
- **Lubricating greases for chassis and brake systems**
- **Lubricating greases for plastic lubrication**
- **Lubricating greases for fittings**
- **Lubricating greases for electrical contacts**
- **Rail lubricants**
- **Environmentally compatible lubricating greases**
- **Lubricating greases - food processing and pharmaceutical industry**
- **Lubricating greases for the textile industry**

## CORE RANGE

Ask about our local custom solutions



## Lubricating greases for roller and plain bearings

For various demanding industrial applications BECHEM offers a wide range of lubricating greases for roller and plain bearings. It covers high-performance high temperature and low temperature lubricating greases, heavy-duty greases and different for-life lubricants e.g. for automotive applications.

Product	Base oil	Thickener	NLGI-grade	Kinematic viscosity at 40 °C /100 °C [mm <sup>2</sup> /s]		Working temperature range [°C] <sup>1)</sup>	Description
				100	9		
<b>BECHEM High-Lub L 1 EP</b> 9003101 	Mineral oil	Lithium soap	1	100 9	-30 120 140	Long-term lubricating grease, good water and temperature resistance, excellent pumpability in central lubrication systems, EP-properties, corrosion protection	
<b>BECHEM High-Lub L 2</b> 9003001 	Mineral oil	Lithium soap	2	100 9	-30 120 140	Long-term lubricating grease, good temperature resistance, excellent pumpability in central lubrication systems, excellent water resistance, corrosion protection	
<b>BECHEM High-Lub L 2 EP</b> 9003931 	Mineral oil	Lithium soap	2	100 9	-30 120 140	Long-term lubricating grease, good temperature resistance, excellent pumpability in central lubrication systems, excellent water resistance, EP-properties, corrosion protection	
<b>BECHEM High-Lub L 2 MO</b> 9004401 	Mineral oil	Lithium soap	2	100 9	-30 120	Heavy-duty/long-term lubricating grease, good temperature resistance, excellent pumpability and water resistance, high load-carrying capacity through solid lubricants and EP-additives	
<b>BECHEM High-Lub L 3</b> 9003051 	Mineral oil	Lithium soap	3	100 9	-20 120	Long-term lubricating grease, good temperature resistance, excellent pumpability in central lubrication systems, excellent water resistance, corrosion protection	
<b>BECHEM High-Lub LM 0 EP</b> 6008002 	Mineral oil	Lithium soap	0	105 10	-40 140	Long-term lubricating grease, good pumpability in central lubrication systems, excellent water resistance, EP properties, good low-temperature properties, corrosion protection	
<b>BECHEM High-Lub LM 3 EP</b> 6008061 	Mineral oil	Lithium soap	3	105 10	-30 140	Long-term lubricating grease, excellent pumpability in central lubrication systems, excellent water resistance, EP-properties, good low-temperature properties, corrosion protection	
<b>BECHEM High-Lub LM 2 EP</b> 6008011 	Mineral oil	Lithium soap	2	105 10	-40 140	Long-term lubricating grease, excellent pumpability in central lubrication systems, excellent water resistance, EP-properties, good low-temperature properties, corrosion protection	

Universal, multipurpose and long-life greases

<sup>1)</sup> Value marked in grey indicates short term maximum temperature..

Product	Base oil	Thickener	NLGI-grade	Kinematic viscosity at 40 °C /100		Description
				°C [mm <sup>2</sup> /s]	Working temperature range [°C] 1)	
<b>BECHEM High-Lub KLF 2 K</b> 9004351 	Mineral oil	Lithium soap	2	160 15	-20 120 140	Heavy-duty grease, excellent pumpability and water resistance, good corrosion protection, outstanding wear protection, contains black solid lubricants, dry running properties
<b>BECHEM High-Lub LT 2 EP-H</b> 9004781 	Mineral oil	Lithium soap	2	160 14,5	-20 120 140	Long-term lubrication, excellent water resistance, excellent corrosion protection, excellent pumpability in central lubrication systems, EP-properties, contains adhesive additives
<b>BECHEM High-Lub LT 1 EP</b> 9004021 	Mineral oil	Lithium soap	1	180 15	-30 140	EP-grease with extended application temperature range, good water resistance, excellent corrosion protection, special pumpability in central lubrication systems
<b>BECHEM High-Lub LT 3 EP</b> 9004011 	Mineral oil	Lithium soap	3	180 15	-20 140	EP-grease with extended application temperature range, excellent water resistance, excellent corrosion protection, good pumpability in central lubrication systems
<b>BECHEM High-Lub LFB 2000</b> 9004751 	Mineral oil	Lithium soap	2	180 15	-20 140	EP-grease, wide application temperature range, excellent pumpability and water resistance, excellent corrosion and wear protection, contains light-colored solid lubricants, emergency running properties
<b>BECHEM High-Lub LT 2 EP-SEB</b> 9003901 	Mineral oil	Lithium soap	2	180 15	-20 150	EP-grease, very wide application temperature range, excellent pumpability, resistant to water, excellent corrosion protection
<b>BECHEM High-Lub LT 2 EP</b> 9004501 	Mineral oil	Lithium soap	2	180 15	-30 140	Multi-purpose EP-grease, wide application temperature range, excellent water resistance, excellent corrosion and wear protection, excellent pumpability in central lubrication systems
<b>BECHEM High-Lub LT 2 EP-400</b> 9004212 	Mineral oil	Lithium soap	2	430 27	-20 140	Heavy-duty grease, extensive application temperature range, excellent water resistance, excellent corrosion protection, excellent pumpability, increased base oil viscosity, EP-properties
<b>BECHEM High-Lub SW 2</b> 9004372 	Mineral oil	Special calcium soap	1-2	100 9	-25 80	Corrosion protection grease for roller bearings, plain bearings, and ropes, for aggressive ambient conditions, extremely high level wear protection through EP additives, water-resistant, excellent corrosion protection, excellent pumpability

All indications and values correspond to latest knowledge and do not represent any product specification.









Product	Base oil	Thickener	NLGI-grade	Kinematic viscosity at 40 °C /100		Description
				°C [mm <sup>2</sup> /s]	Working temperature range [°C] <sup>1)</sup>	
<b>BECEM Ceritol CF 2</b> 6001351 	Mineral oil	Calcium complex soap	2	60 6	-40 140	EP-grease with extended application temperature range, excellent water resistance and pumpability in central lubrication systems, excellent corrosion protection, high load-carrying capacity
<b>BECEM High-Lub FA 67-400</b> 9004321 	Mineral oil	Lithium-Calcium-Soap	2	400 30	-20 130	Long-term lubricating grease, good sealing qualities, excellent water resistance, outstanding corrosion protection, high wear protection, good pumpability in central lubrication systems, EP properties 
<b>Berulub FB 34</b> 9012269 	Polyalphaolefin (PAO)	Aluminium complex soap	1	400 40	-40 160	Synthetic universal lubricant, resistant to hot water, suitable for central lubrication systems, H1 registered, certified according to ISO 21469 
<b>Berutemp FB 38</b> 9012619 	Polyalphaolefin (PAO)	Barium complex soap	1	160 20	-40 180	Roller and plain bearing lubrication for high loads, outdoor conditions and vibrations, suitable for low and high temperatures, reliable corrosion protection and wear, e.g. for threaded spindles, worm gears, top-arm bearings (textile industry)
<b>Berulub FG-H 2 EP</b> 2900709 	Polyalphaolefin (PAO)	Special calcium complex soap	1-2	150 18,5	-40 160	Universal lubricant, high load-carrying properties, good adhesion and sealing effect, reliable corrosion protection and wear, resistant to ageing, water, disinfectants and cleaners, H1 registered, halal and kosher certified, certified according to ISO 21469 
<b>Berulub FG-H 2 SL</b> 2901709 	Synthetic hydrocarbon	Special calcium complex soap	2	50 8	-45 160 200	High-performance lubricant, good adhesion and sealing properties, resistant to water and aging, reliable corrosion protection, suitable for central lubrication systems, H1 registered, Halal and Kosher certified, certified according to ISO 21469 
<b>Berulub FA 37</b> 9011061 	White oil	Aluminium complex soap	2	67 9	-20 120	For the lubrication of roller, plain bearings and sanitary fittings, resistant to hot and cold water, transparent, H1 registered 
<b>Berulub FA 46</b> 9012791 	White oil	Aluminium complex soap	2	67 9	-20 120	For the lubrication of roller, plain bearings and sanitary fittings, resistant to hot and cold water, transparent, contains solid lubricants, increased load carrying capacity, color white, H1 registered 
<b>Berulub 52142</b> 9013801 	Mineral oil, Polyalphaolefin (PAO)	Polyurea	2	90 10	-35 160	Semi-synthetic high temperature grease for bearings and sliding surfaces in vehicles, suitable for high pressures and shock loads, prevents stick-slip and fretting corrosion 

<sup>1)</sup> Value marked in grey indicates short term maximum temperature..

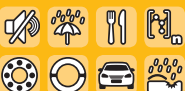







Product	Base oil	Thickener	NLGI-grade	Kinematic viscosity at 40 °C /100		Description
				°C [mm <sup>2</sup> /s]	Working temperature range [°C] 1)	
<b>Berulub WP 402 H1</b> 9011092 	Polybutene, White oil	Aluminium complex soap	1-2	400 30	-20 150	Long-term lubricating grease, excellent water resistance, excellent consistency-temperature behavior, high corrosion protection, EP-properties, for pellet presses (wood and animal feed industry), certified according to ISO 21469
<b>Beruplex CS 2 EP</b> 6001491 	Mineral oil	Calcium complex soap	2	150 13	-25 140	EP-grease, wide application temperature range, excellent water resistance, excellent corrosion protection, excellent pumpability in central lubrication systems, high load-carrying capacity
<b>Beruplex CS 2-1 EP</b> 6001521 	Mineral oil	Calcium complex soap	1-2	150 13	-30 140 180	Like <b>Beruplex CS 2 EP</b> , however softer consistency to improve the pumpability
<b>Beruplex HTA</b> 9006801 	Mineral oil	Aluminium complex soap	2	230 15	-25 190 200	High-temperature grease with a wide application temperature range, good corrosion protection, excellent pumpability in central lubrication systems, for dusty environments, e.g. vacuum cleaners, air motors, hot-gas blowers of tension frames (textile industry)
<b>Berutox MB 2-H</b> 9007451 	Mineral oil	Polyurea	2	300 18	-5 200 220	Long-term lubricating grease with outstanding sealing capacities, good wear protection, reliable corrosion protection even in presence of aggressive water
<b>Berutemp M 21 HT</b> 9007212 	Mineral oil	Polyurea	1-2	490 32	-20 180	Long-term lubricating grease, outstanding consistency-temperature behavior even at overheating, excellent resistance to water, excellent corrosion and wear protection, EP-properties
<b>Berutox M 21 EPK</b> 9007281 	Mineral oil	Polyurea	1-2	490 32	-20 160	Multi-purpose grease for plastic/metal slide pairings, high corrosion and wear protection, good adhesion, resistant to oxidation, water, and steam, water repellent, EP-properties, e.g. for top-arm bearings and variator systems of ring spinning machines
<b>Berutox M 21 KN</b> 9007601 	Mineral oil	Polyurea	1-2	490 32	-20 180	Long-term lubricating grease, outstanding consistency-temperature-behavior, excellent resistance to water, excellent corrosion and wear protection, EP-properties
<b>Beruplex KS 22</b> 6008441 	Mineral oil	Special calcium complex soap	1-2	160 13	-30 150 180	EP-grease, extremely wide application temperature range, excellent corrosion protection, excellent pumpability, excellent water resistance and adhesion, excellent sealing qualities

↓ Lubricating greases for high temperatures

All indications and values correspond to latest knowledge and do not represent any product specification.

Product	Base oil	Thickener	NLGI-grade	Kinematic viscosity cP [mm <sup>2</sup> /s]		Description
				at 40 °C	at 100 °C	
<b>Berutemp A 17</b> 9005001 	Mineral oil	Bentonite	2	250 – 150 160	-20	High-temperature grease with good lubrication effect, even under influence of water, high resistance to oxidation
<b>BECHEM Ceritol PSA 12 H</b> 6006101 	Mineral oil	Special polyurea	1–2	240 17	-20 160	High-temperature grease, no pipe clogging in central lubrication systems even in case of thermal radiation, excellent sealing qualities, good corrosion and wear protection
<b>Beruplex LI-EP 2</b> 5307201 	Mineral oil	Lithium complex soap	2	180 16	-30 150	Long-term EP grease, excellent corrosion protection and wear, excellent pumpability, even under shock load, protection against high temperatures and moisture, e.g. for wheel bearings, electric motor bearings, textile industry: ring spinning rollers, underlay rollers of combing machines
<b>Berutox VPT 54-2</b> 9013169 	Perfluoropolyether (PFPE)	Polytetrafluoroethylene (PTFE)	2	210 20	-30 230	Reduction of friction and wear at high temperatures, suitable for all sliding speeds permitted for grease lubrication, with a more solid consistency, certified according to ISO 21469, also available in NLGI Class 1
<b>Berutox VPT 64-2</b> 9013509 	Perfluoropolyether (PFPE)	Polytetrafluoroethylene (PTFE)	2	330 30	-30 260	Long-term lubricating grease, even for vacuum, radiation and aggressive chemicals, excellent compatibility with plastics, outstanding thermal stability, odorless, also available in NLGI Class 1
<b>Berutemp 500 T 2</b> 9016709 	Perfluoropolyether (PFPE)	Polytetrafluoroethylene (PTFE)	1–2	510 45	-20 260	Long-term lubricating grease, even for vacuum, radiation, solvents and aggressive chemicals, outstanding compatibility with plastics, high thermal stability, high wear and corrosion protection, resistant to acids, bases, disinfectants, H1 registered, halal and kosher certified, certified according to ISO 21469
<b>Berutemp 500 G 2</b> 9017109 	Perfluoropolyether (PFPE)	Gel	2	510 45	-35 260	High-temperature and long-term lubricating grease for ejector pins/slides (plastic industry) and plain bearings, compatible with plastics and elastomers, UV-indicator, H1 registered, halal and kosher certified, certified according to ISO 21469
<b>Berutox FH 28 EPK 2</b> 9013739 	Polyalphaolefin (PAO)	Polyurea	2	400 40	-30 180	Long-term lubricating grease, outstanding consistency-temperature behavior even at overheating, excellent resistance to water, excellent corrosion and wear protection, EP-properties
<b>Berutemp PA 1 EP</b> 6005459 	Polyalphaolefin (PAO)	Polyurea	1	400 40 200 220	-30	Fully synthetic long-term lubricating grease, good resistance to water, excellent corrosion and wear protection

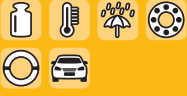
<sup>1)</sup> Value marked in grey indicates short term maximum temperature..





Product	Base oil	Thickener	NLGI-grade	Kinematic viscosity at 40 °C /100 °C [mm <sup>2</sup> /s]		Description
					Working temperature range [°C] 1)	
<b>Berutemp PA 1 MO</b> 6005639 	Polyalphaolefin (PAO)	Polyurea	1	400 40	-35 200 240	Fully synthetic grease, contains solid lubricants for high mechanical loads and dry-running properties///, good resistance to water, excellent corrosion and wear protection 
<b>Berutox FH 28 KN</b> 9013629 	Polyalphaolefin (PAO)	Polyurea	1-2	400 40	-30 180 200	Synthetic long-term lubricating grease, outstanding consistency-temperature behavior, excellent chemical and water resistance, excellent corrosion and wear protection, EP-properties, H2 registered, e.g. for bearing lubrication of dryer cylinders 
<b>Berutemp FH 28 G</b> 9013779 	Polyalphaolefin (PAO)	Polyurea	1	400 40	-40 200	Synthetic grease, resistant to hot and cold water, steam, aqueous-alkaline and aqueous-acidic liquids, high corrosion and wear protection, contains graphite
<b>Berutemp FB 38</b> 9012619 	Polyalphaolefin (PAO)	Barium complex soap	1	160 20	-40 180	Roller and plain bearing lubrication for high loads, outdoor conditions and vibrations, suitable for low and high temperatures, reliable corrosion protection and wear, e.g. for threaded spindles, worm gears, top-arm bearings (textile industry)
<b>Beruplex RO 2</b> 9013069 	Polyalphaolefin (PAO)	Barium complex soap	2	210 25	-25 180 200	Synthetic high-performance lubricating grease for high temperatures and use in outdoor weather conditions, good pressure-absorption capacity, resistant to water and media, good corrosion and wear protection
<b>Berutemp 170</b> 9014789 	Synthetic oil	Polytetrafluoroethylene (PTFE)	1-2	180 19	-20 200	Lifetime lubricating grease, suitable for very high temperatures, recoatable, good resistance to water, low evaporation tendency, good elastomer compatibility, good EP/AW properties 

All indications and values correspond to latest knowledge and do not represent any product specification.

Product	Base oil	Thickener	NLGI-grade	Kinematic viscosity at 40 °C / (100		Description		
				°C [mm <sup>2</sup> /s]	Working temperature range [°C] 1)			
Lubricating greases for low temperatures and high speeds	<b>Berutox FE 18 EP</b> 9007371 	Mineral oil	Polyurea	2	100 11	-20 140	High-performance grease to lubricate high-speed roller and plain bearings, excellent water resistance, excellent corrosion and wear protection, excellent pumpability	
	<b>BECEM High-Lub FA 67-2</b> 9003071 	Mineral oil	Lithium-Calcium-Soap	2	100 11	-30 130	Long-term lubricating grease, excellent corrosion and wear protection, suitable for high loads and high speeds, excellent water resistance and pumpability	
	<b>Berutox FB 22</b> 9012699 	Polyalphaolefin (PAO)	Barium complex soap	2	50 8	-40 180 200	For long-term lubrication at high speeds, good consistency-temperature-behavior, excellent water resistance, excellent corrosion and wear protection, good pumpability	
	<b>Berutox FB 48-1</b> 9012589 	Polyalphaolefin (PAO)	Special calcium complex soap	1	50 8	-50 160	Multi-purpose grease for long-term lubrication, media-resistant, vibration and noise damping, excellent corrosion and wear protection, outstanding pumpability	
	<b>Berulub KR-EP 2</b> 9012709 	Synthetic oil combination	Lithium soap	2	15 4	-50 120	Low-temperature and high-speed lubricant, low start-up resistance at low temperatures, protects against corrosion and moisture	
Lubricating greases for high loads	<b>Beruplex PMC 42 F</b> 6008521 	Mineral oil	Special calcium complex soap	1-2	400 26	-20 140	Roller and plain bearing grease for high to very high loads, excellent water resistance and pumpability, excellent corrosion protection, contains solid lubricants and EP-additives	
	<b>Beruplex PMC 40 F</b> 6008481 	Mineral oil	Special calcium complex soap	0	440 26	-20 140	Chain lubricant for high to extremely high loads, good water resistance and pumpability, excellent corrosion protection, contains solid lubricants and EP additives	
	<b>BECEM High-Lub FA 67-220</b> 9004311 	Mineral oil	Lithium-Calcium-Soap	2	220 19	-30 140	For long-term lubrication, good sealing qualities, excellent water resistance, excellent corrosion protection, excellent pumpability in central lubrication systems, EP-properties	
	<b>BECEM High-Lub FA 67-400 KS</b> 9004771 	Mineral oil	Lithium-Calcium-Soap	2	400 30	-20 140	Long-term lubricating grease, good sealing qualities, excellent water resistance, outstanding corrosion protection, good pumpability in central lubrication systems, EP-properties	

1) Value marked in grey indicates short term maximum temperature..



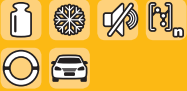







Product	Base oil	Thickener	NLGI-grade	Kinematic viscosity at 40 °C (100		Description
				°C [mm <sup>2</sup> /s]	Working temperature range [°C] 1)	
<b>BECEM High-Lub FA 40 MO</b> 9004331 	Mineral oil	Lithium-Calcium-Soap	2	400 30	-20 120	For long-term lubrication, good sealing qualities, excellent water resistance and pumpability, excellent corrosion protection, high load-carrying capacity, with solid lubricants and EP-additives
<b>BECEM High-Lub FA 67-400</b> 9004321 	Mineral oil	Lithium-Calcium-Soap	2	400 30	-20 130	Long-term lubricating grease, good sealing qualities, excellent water resistance, outstanding corrosion protection, high wear protection, good pumpability in central lubrication systems, EP properties
<b>BECEM High-Lub FA 50</b> 9003961 	Mineral oil	Lithium-Calcium-Soap	2	920 42	-20 120	Long-term lubrication grease for high to very high loads, excellent water resistance, excellent corrosion protection, contains highly-viscous mineral base oil and EP-additives
<b>BECEM High-Lub FA 50 MO</b> 9003971 	Mineral oil	Lithium-Calcium-Soap	2	1200 47	-20 120	Long-term lubricating grease for high to very high loads, excellent water resistance, excellent corrosion protection, even if there is risk of standstill corrosion, highly viscous mineral oil, contains solid lubricants and EP-additives
<b>Berutemp FB 38</b> 9012619 	Polyalphaolefin (PAO)	Barium complex soap	1	160 20	-40 180	Roller and plain bearing lubrication for high loads, outdoor conditions and vibrations, suitable for low and high temperatures, reliable corrosion protection and wear, e.g. for threaded spindles, worm gears, top-arm bearings (textile industry)
<b>Berulub 52142</b> 9013801 	Mineral oil, Polyalphaolefin (PAO)	Polyurea	2	90 10	-35 160	Semi-synthetic high temperature grease for bearings and sliding surfaces in vehicles, suitable for high pressures and shock loads, prevents stick-slip and fretting corrosion

All indications and values correspond to latest knowledge and do not represent any product specification.



## Lubricating greases for open and closed gears

BECHEM products reliably cope with the extremely demanding requirements of gears and open drives in the heavy industry. BECHEM's on site technical service ensures correct application and contributes to a reduction in repair costs and downtime. Thanks to reduced consumption savings are also made in terms of lubricant costs.

Product	Base oil	Thickener	NLGI-grade	Kinematic viscosity at 40 °C /100		Description
				°C [mm <sup>2</sup> /s]	Working temperature range [°C] <sup>1)</sup>	
<b>BECHEM High-Lub LT 0 EP</b> 9003612 	Mineral oil	Lithium soap	0-00	180 15	-20 120	Multi-purpose semi-fluid grease for closed gear units, excellent corrosion protection, outstanding resistance to water, good adhesion and flowability
<b>BECHEM Ceritol CS 415 EP</b> 6001541 	Mineral oil	Calcium complex soap	00*	160 13	-20 120	Semi-fluid grease for closed gear units, excellent corrosion protection, outstanding thermal and water resistance, good adhesion, excellent flowability
<b>Berulit 443</b> 9006501 	Mineral oil	Aluminium complex soap	2	260 16	-20 180	Priming lubricant for open gear drives and lubricating paste, very high graphite content, excellent wear protection, good adhesion, high load-carrying capacity, not sprayable
<b>Berulit EL 420</b> 9006511 	Mineral oil	Aluminium complex soap	0-00	490 32	-20 180	Running-in lubricant for open gears, excellent wear protection, good adhesion, very high load-carrying capacity, contains graphite, application by means of spray units and dip baths
<b>Berulit GA 400</b> 9006351 	Mineral oil	Aluminium complex soap	0-00	490 32	-20 180	Operating lubricant for open gear drives, extremely high base oil viscosity excellent wear protection, extremely high load-carrying capacity, good adhesion, contains graphite, preferably applied by spray equipment
<b>Berulit GA 800</b> 9006531 	Mineral oil	Aluminium complex soap	0-00	1000 45	-10 180	Operating lubricant for open gear drives, increased base oil viscosity, excellent wear protection, very high load-carrying capacity, strong adhesion, contains graphite, suitable for dip baths or circulating systems, sprayable
<b>Berulit GA 800 Fluid</b> 9006521 	Mineral oil	Aluminium complex soap	000*	1000 45	-10 120	Operating lubricant for open gear drives, increased base oil viscosity, excellent wear protection, very high load-carrying capacity, strong adhesion, contains graphite, suitable for dip baths or circulating systems, sprayable
<b>BECHEM Ceritol SGR 4-00-9 P</b> 6005341 	Mineral oil	Polyurea	00*	180 14	-30 100	Semi-fluid grease for heavy-duty spur gears, excellent corrosion protection, outstanding water resistance, good adhesion and flowability, also available in NLGI-grades 0

<sup>1)</sup> Value marked in grey indicates short term maximum temperature.. \* The indication refers to the unworked penetration

Product	Base oil		Thickener	NLGI-grade	Kinematic viscosity at 40 °C /100 °C [mm <sup>2</sup> /s]	Working temperature range [°C] 1)	Description
<b>Berutox M 21 EPK 420</b> 9014701 	Mineral oil		Polyurea	00	490 32	-5 160	Semi-fluid grease for heavy-duty roller bearings, gear drives and worm gears, excellent corrosion protection, very adhesive, outstanding resistance to water, good flowability
<b>Berulub FB 34-00</b> 9012309 	Polyalphaolefin (PAO)		Aluminium complex soap	00	400 40	-40 160	Semi-fluid grease to lubricate closed gear units, suitable for all permitted semi-fluid grease sliding speeds, cream-colored, certified according to ISO 21469 
<b>Berutemp PA 415 GR</b> 6005529 	Polyalphaolefin (PAO)		Polyurea	00*	400 40	-40 200	Semi-fluid grease for closed gear units, plain bearings, joints and chain bolts, excellent adhesion and water resistance, dry lubrication up to +450 °C due to graphite as solid lubricant
<b>Berulub FG 8 EP</b> 9012449 	Polyglycol		Lithium soap	00	120 20	-40 120	Synthetic fluid grease for heavy-duty spur and worm gears as well as plain bearings, excellent adhesion, high resistance to ageing, excellent flowability
<b>BECEM High-Lub LIC-00</b> 9003881 	Mineral oil, Synthetic oil		Lithium soap	00	25 5	-30 80	Semi-fluid grease for gear units and to supply lubrication points on trucks via central lubrication systems, reliable wear and corrosion protection even in case of water absorption
<b>BECEM High-Lub LIC-000</b> 9003891 	Mineral oil, Synthetic oil		Lithium soap	1	25 5	-30 80	Semi-fluid grease for gear units and to supply lubrication points on trucks via central lubrication systems, reliable wear and corrosion protection even in case of water absorption
<b>Berulit GA 2500</b> 9006541 	Mineral oil, Synthetic oil		Aluminium complex soap	00	2500 100	5 200	Operating lubricant for open gear drives, very high base oil viscosity, excellent wear protection, very high load-carrying capacity, strong adhesion, contains graphite, preferably applied through spray equipment 
<b>Berulit GA 2500 Fluid</b> 9006561 	Mineral oil, Synthetic oil		Aluminium complex soap	000*	3175 113	0 200	Operating lubricant for open gear drives, increased base oil viscosity, excellent wear protection, very high load-carrying capacity, strong adhesion, contains graphite, suitable for dip baths or circulating systems, sprayable

All indications and values correspond to latest knowledge and do not represent any product specification.





## Lubricating greases for chassis and brake systems

BEICHEM lubricants for chassis technology meet the high demands by supporting joints, ball joints and constant velocity joints: For-life lubrication, compatibility with plastics and elastomers, low friction values at oscillating movements, low increase in adjustment momentum at low temperatures, protection against corrosion and fretting corrosion.

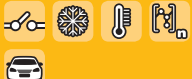

Product	Base oil	Thickener	NLGI-grade	Kinematic viscosity at 40 °C /100		Description
				°C [mm <sup>2</sup> /s]	Working temperature range [°C] <sup>1)</sup>	
<b>Berulub CVN 140</b> 9007262 	Mineral oil	Lithium soap	1-2	140 13,5	-35 130	Long-term lubricating grease for heavy-duty constant velocity joints, contains solid lubricants, optimal wear and corrosion protection, compatible with conventional boot materials
<b>Beruplex LI-EP 2</b> 5307201 	Mineral oil	Lithium complex soap	2	180 16	-30 150	Long-term EP grease, excellent corrosion protection and wear, excellent pumpability, even under shock load, protection against high temperatures and moisture, e.g. for wheel bearings, electric motor bearings, textile industry: ring spinning rollers, underlay rollers of combing machines
<b>Berulub FE 16</b> 9012689 	Polyglycol	Lithium soap	1-2	120 20	-40 120	Synthetic special lubricant for heavy-duty plain bearings, especially suitable for tribological pairings metal/plastic and metal/elastomer, e.g. as installation aid for hydraulic brake systems
<b>Beruplex LG 1-30</b> 9012219 	Polyglycol	Lithium complex soap	1-2	30 7	-50 145	For slide pairings metal/elastomer and metal/plastic, wide application temperature range, good adhesion, temperature-resistant, corrosion-resistant, oxidation-resistant, copper corrosion protection, contains PTFE and EP/AW additives, e.g. for electric parking brakes
<b>Beruplex LG 21 F</b> 9012349 	Polyglycol	Lithium complex soap	1-2	390 66	-40 145	Synthetic special lubricant for tribological pairings metal/elastomer, EPDM and plastic, brake systems, temperature-stable/oxidation-stable, good adhesion, good corrosion protection, water-resistant, e.g. for clutch systems, brake technology, steering column seal
<b>Berulub CVH 170</b> 9007382 	Mineral oil, Polyalphaolefin (PAO)	Polyurea	1-2	170 14	-35 160	Long-term grease for constant velocity joints, suitable for high temperatures, contains solid lubricants, excellent corrosion and wear protection, compatible with conventional boot materials
<b>Berulub CVH 170 LF</b> 9007392 	Mineral oil, Polyalphaolefin (PAO)	Polyurea	1-2	170 14	-35 160	Same properties as <b>Berulub CVH 170</b> but considerably reduced friction value based on special additive combination

<sup>1)</sup> Value marked in grey indicates short term maximum temperature.. \* The indication refers to the unworked penetration

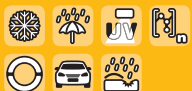

Product			NLGI-grade	Kinematic viscosity at 40 °C /100		Description
	Base oil	Thickener		°C (mm <sup>2</sup> /s)	Working temperature range [°C] <sup>1)</sup>	
<b>Beruglide L</b> 9014729 	Perfluoropolyether (PFPE)	Polytetrafluoroethylene (PTFE)	1–2*	160 16	-40 190	For plastic and polymer materials, excellent resistance to oxidation/aggressive media, good noise damping properties, contains PTFE, H1 registered, halal and kosher certified, certified according to ISO 21469 
<b>Berulub FK-VPT 380</b> 9013309 	Perfluoropolyether (PFPE)	Polytetrafluoroethylene (PTFE)	–	325 30	-40 250	PTFE containing special dispersion for life-time lubrication of plug connectors, high oxidation resistance, excellent compatibility with plastics, prevents formation of impurity layers
<b>Berutemp 500 G 2</b> 9017109 	Perfluoropolyether (PFPE)	Gel	2	510 45	-35 260	High-temperature and long-term lubricating grease for ejector pins/slides (plastic industry) and plain bearings, compatible with plastics and elastomers, UV-indicator, H1 registered, halal and kosher certified, certified according to ISO 21469 
<b>Berulub ND-Dispersion 10</b> 6400019 	Perfluoropolyether (PFPE)	–	–	325 20	-40 250	For noise damping in automotive applications, and for protection of electrical contacts, outstanding plastic/elastomer/non-ferrous metal compatibility, very high thermal stability, excellent resistance to oxidation
<b>Berulub LHC 2 M</b> 9003489 	Polyalphaolefin (PAO)	Lithium soap	2	18 4	-50 140	For long-term lubrication of the material combinations metal/plastic, plastic/plastic and metal/non-ferrous metal, excellent low-temperature properties, prevents stick-slip, with UV-indicator, contains PTFE, also available in NLGI grade 3
<b>Berulub FR 82</b> 9012129 	Polyalphaolefin (PAO)	Lithium soap	2	30 6	-50 140	Fully synthetic low-temperature grease suitable for material combinations plastic/plastic, plastic/metal, prevents stick-slip, emergency running properties based on EP additives, UV-indicator
<b>BECEM Ceritol PK 1 Soft</b> 6006139 	Polyalphaolefin (PAO)	Polyurea	0–1	32 6	-60 140	Special lubricant for metal and polymer materials, excellent low temperature behavior, good corrosion protection, resistant to oxidation, contains EP-additives, prevents stick-slip, available with UV-indicator
<b>BECEM Ceritol PK 1</b> 6005519 	Polyalphaolefin (PAO)	Polyurea	1	50 8	-50 160	Long-term lubrication and corrosion protection of roller bearings and plain bearings, mechanisms and switchgear, wide temperature range, EP-additives, resistant to oxidation, protects against aggressive media
<b>Berulub FH 57</b> 9013829 	Polyalphaolefin (PAO)	Polyurea	1–2*	150 20	-40 160	Fully synthetic lubricating grease for long-term lubrication of polymer components, excellent noise damping properties, excellent low temperature behavior, contains PTFE

<sup>1)</sup> The indication refers to the unworked penetration <sup>1)</sup> Value marked in grey indicates short term maximum temperature..

Product	Base oil	Thickener	NLGI-grade	Kinematic viscosity at 40 °C / 100 °C [mm <sup>2</sup> /s]		Working temperature range [°C] <sup>1)</sup>	Description
				40 °C	100 °C		
<b>Berulub FH 28</b> 9013599 	Polyal-phaolefin (PAO)	Polyurea	2	400 40	-40 160	Fully synthetic grease for long-term lubrication of small gear units with friction bodies of non-ferrous metals and/or plastics, contains PTFE	
<b>Berusoft 15</b> 9013879 	Polyal-phaolefin (PAO)	Polyurea	1-2	900 100	-40 150	Synthetic special grease for noise damping, good plastic and elastomer compatibility, good oxidation resistance, minimal oil separation, prevents stick-slip, noise damping value: high, also available with UV-indicator, H2-registered	
<b>Berusoft 20</b> 9013889 	Polyal-phaolefin (PAO)	Polyurea	0-1*	1400 150	-40 150	Synthetic special grease for noise damping, good plastic and elastomer compatibility, good oxidation resistance, minimal oil separation, prevents stick-slip, noise damping value: high, also available with UV-indicator, H2-registered	
<b>Berutox FB 48-1</b> 9012589 	Polyal-phaolefin (PAO)	Special calcium complex soap	1	50 8	-50 160	Multi-purpose grease for long-term lubrication, media-resistant, vibration and noise damping, excellent corrosion and wear protection, outstanding pumpability	
<b>Berulub FG-H 2 EP</b> 2900709 	Polyal-phaolefin (PAO)	Special calcium complex soap	1-2	150 18,5	-40 160	Universal lubricant, high load-carrying properties, good adhesion and sealing effect, reliable corrosion protection and wear, resistant to ageing, water, disinfectants and cleaners, H1 registered, halal and kosher certified, certified according to ISO 21469 	
<b>Berulub PMP 75</b> 9011649 	Polyal-phaolefin (PAO)	Polytetrafluoroethylene (PTFE)	1-2*	75 12	-50 140	For long-term lubrication of the material combinations metal/plastic, plastic/plastic and metal/non-ferrous metal, excellent low temperature properties, suitable for high surface pressures, prevents stick-slip, with UV-indicator	
<b>Berulub XP 3000</b> 9012189 	Polyal-phaolefin (PAO)	Gel	1-2	2400 180	-40 140	Good plastic and elastomer compatibility, high adhesion, good low temperature properties, very low oil separation, excellent corrosion protection, noise damping, available with UV-indicator	
<b>Berulub FR 32-21</b> 9011339 	Polyal-phaolefin (PAO)	Special lithium soap	1-2	32 6	-50 140	For long-term lubrication of the material combinations metal/polymer, ideal e.g. for actuators, excellent low-temperature behavior, prevents stick-slip, resistant to water and oxidation, very good sound insulation, good EP properties, with UV indicator	
<b>Berulub FR 16</b> 9012389 	Polyal-phaolefin (PAO)	Special lithium soap	2	32 6	-50 140	Suitable for the material combinations plastic/plastic and plastic/metal, excellent low temperature behavior, resistant to water and oxidation, prevents stick-slip, contains PTFE	

All indications and values correspond to latest knowledge and do not represent any product specification.

Product	Base oil	Thickener	NLGI-grade	Kinematic viscosity at 40 °C /100 °C [mm <sup>2</sup> /s]		Description
				Working temperature range [°C] <sup>1)</sup>		
<b>Berulub FR 43</b> 9011189 	Polyal-phaolefin (PAO)	Special lithium soap	2	32 6	-50 140	Suitable for material combinations plastic/plastic and plastic/metal, outstanding low temperature behavior, resistant to water and oxidation, prevents stick-slip, contains PTFE, available with UV-indicator 
<b>Berulub FR 150-21</b> 9011349 	Polyal-phaolefin (PAO)	Special lithium soap	1-2	150 20	-50 140	For long-term lubrication of the material combinations metal/polymer, prevents stick-slip, excellent low-temperature behavior, resistant to water and oxidation, very good sound insulation, good EP properties, with UV indicator
<b>Berulub FR 400-21</b> 9011369 	Polyal-phaolefin (PAO)	Special lithium soap	1-2	400 40	-40 140	For long-term lubrication of the material combinations metal/polymer, prevents stick-slip, resistant to water and oxidation, very good low-temperature behavior, very good sound insulation, good EP properties, with UV indicator
<b>Berusoft 10</b> 9011609 	Polyal-phaolefin (PAO)	Special lithium soap	2	600 70	-40 150	Synthetic special grease for noise damping, good compatibility with plastics and elastomers, good resistance to oxidation, minimal oil separation, prevents stick-slip, noise damping value: medium to high, available with UV-indicator
<b>Berulub FR 3000-21</b> 9011359 	Polyal-phaolefin (PAO)	Special lithium soap	1-2	3400 300	-40 140	Maximum insulation properties (e.g. for kinematics components) for the material combinations metal/polymer, prevents stick-slip, resistant to water and oxidation, high adhesion, very good low-temperature behavior, good EP properties, with UV indicator
<b>Beruplex LHC 10</b> 9012809 	Polyal-phaolefin (PAO)	Lithium complex soap	0-1	32 6	-50 140	Synthetic lubricating grease for long-term lubrication of the material combinations metal/plastic, plastic/plastic, water resistant, outstanding low-temperature behavior, good noise damping properties, contains PTFE
<b>Beruplex LO 10</b> 9003599 	Polyal-phaolefin (PAO)	Lithium complex soap	0-1	48 8	-50 140	Fully synthetic multi-purpose grease for long-term lubrication of plastic/plastic, plastic/metal and steel/steel, excellent low-temperature behavior, noise damping, resistant to oxidation, water resistant, corrosion protection, UV-indicator
<b>Beruplex LO 21</b> 9012149 	Polyal-phaolefin (PAO)	Lithium complex soap	1-2	48 8	-50 140	Fully synthetic multi-purpose grease for long-term lubrication of plastic/plastic, plastic/metal, outstanding low-temperature behavior, noise damping, oxidation-stable, water resistant, corrosion protection, UV-indicator
<b>Berulub FR 16 B</b> 9012419 	Polyal-phaolefin (PAO)	Lithium-Calcium-Soap	2	32 6	-50 140	For material combinations plastic/plastic and plastic/steel, excellent low temperature behavior, resistant to water and oxidation, prevents stick-slip 

<sup>1)</sup> Value marked in grey indicates short term maximum temperature.. \* The indication refers to the unworked penetration



Product			NLGI-grade	Kinematic viscosity at 40 °C / 100 °C [mm <sup>2</sup> /s]		Description
	Base oil	Thickener				
<b>Berulub FE 16</b> 9012689 	Polyglycol	Lithium soap	1-2	120 20	-40 120	Synthetic special lubricant for heavy-duty plain bearings, especially suitable for tribological pairings metal/plastic and metal/elastomer, e.g. as installation aid for hydraulic brake systems
<b>Beruplex LG 1-30</b> 9012219 	Polyglycol	Lithium complex soap	1-2	30 7	-50 145	For slide pairings metal/elastomer and metal/plastic, wide application temperature range, good adhesion, temperature-resistant, corrosion-resistant, oxidation-resistant, copper corrosion protection, contains PTFE and EP/AW additives, e.g. for electric parking brakes
<b>Beruplex LG 21 F</b> 9012349 	Polyglycol	Lithium complex soap	1-2	390 66	-40 145	Synthetic special lubricant for tribological pairings metal/elastomer, EPDM and plastic, brake systems, temperature-stable/oxidation-stable, good adhesion, good corrosion protection, water-resistant, e.g. for clutch systems, brake technology, steering column seal
<b>Beruil FO 36-2</b> 9014929 	Silicone oil	Lithium soap	2	75 31	-50 180	Long-term and life-time lubrication of the material combination plastic/stainless steel, suitable for high and low temperatures, high oxidation resistance
<b>Beruil TS 1</b> 9015059 	Silicone oil	Polytetrafluoroethylene (PTFE)	1-2*	3500 1500	-50 180	Noise damping silicone lubricant for long-term lubrication, good plastic and elastomer compatibility, wide temperature range, water resistant, prevents stick-slip
<b>Beruil FO 22 F</b> 9014839 	Silicone oil	Lithium complex soap	1	75 31	-50 180	Long-term and life-time lubrication of the material combination plastic/stainless steel, elastomer/stainless steel and plastic/plastic, hot and cold water resistant, oxidation resistance
<b>Berulub TCG 1 V</b> 9012192 	Synthetic oil combination	Polytetrafluoroethylene (PTFE)	1*	4100 320	-40 150	Sprayable, multi-purpose paste, prevents stick-slip, low-temperature suitability, high load-carrying capacity, excellent adhesion, contains PTFE, optimal for contacts of steel with PTFE/PA
<b>Beruglide H 50</b> 9014749 	Synthetic oil combination	Polytetrafluoroethylene (PTFE), Special lithium soap	2	30 6	-60 160	Long-term lubrication for plastic/plastic, plastic/metal and non-ferrous metal/non-ferrous metal, excellent low temperature behavior, noise damping, resistant to water, contains PTFE, UV-indicator, hybrid technology
<b>Berulub FR 16 SC</b> 9012719 	Special synthetic oil mixture	Special lithium soap	1	25 5	-50 140	Ideal for the material combinations plastic/plastic and plastic/metal, outstanding low temperature behavior, resistant to water and oxidation, prevents stick-slip, contains PTFE

All indications and values correspond to latest knowledge and do not represent any product specification.



## Lubricating greases for fittings

In close cooperation with the fitting industry BECHEM is permanently developing new lubrication solutions in the demanding and complex field of fitting lubricants. These fulfil or even exceed the required technical, chemical and constructive criteria.

Product	Base oil	Thickener	NLGI-grade	Kinematic viscosity cP [mm <sup>2</sup> /s]		Working temperature range [°C] <sup>1)</sup>	Test mark <sup>2)</sup>	Description
				5000	340			
<b>Berulub PAL 3</b> 5500309 	Ester	Polytetrafluoroethylene (PTFE)	3*	5000 340	-20 150	–		Multi-purpose, low-temperature paste prevents stick-slip, extends relubrication intervals, excellent adhesion, media-resistant, contains PTFE, optimally suited for contact combinations of steel with PTFE/PA
<b>Berutox VPT 54-2</b> 9013169 	Perfluoropolyether (PFPE)	Polytetrafluoroethylene (PTFE)	2	210 20	-30 230	A		Reduction of friction and wear at high temperatures, suitable for all sliding speeds permitted for grease lubrication, with a more solid consistency, certified according to ISO 21469, also available in NLGI Class 1
<b>Berulub OX 100 EP</b> 9011629 	Perfluoropolyether (PFPE)	Inorganic pigment	2*	90 11	-30 200 250	B		Lubricant for oxygen fittings and other parts in oxygen production plants, for oxygen pressure surges up to 140 bar at an application temperature of +60 °C, e.g. in the aerospace industry, BAM inspected
<b>Berulub FU 5</b> 9014309 	Polyalphaolefin (PAO)	Gel	2	400 40	-20 100	C, D, E, G		Short-path multi-purpose grease for lubrication of non-ferrous metal bearing and sanitary hot and cold water fittings, resistant to oxidation
<b>Berulub Hydrohaf 2</b> 9011009 	Polyglycol	Bentonite	2	370 60	-10 150	–		Lubrication of hot and cold water fittings, especially suitable for material combinations metal/elastomer and non-ferrous metal/non-ferrous metal, good plastic and elastomer compatibility
<b>Berasil CDG 352</b> 9011409 	Silicone oil	Polytetrafluoroethylene (PTFE)	2	265 110	-40 150	C, D, E, G		Lifetime lubrication of hot and cold water fittings, suitable for tribological pairings plastic/plastic, plastic/metal, ceramic/ceramic and ceramic/plastic, high adhesive strength and water resistance
<b>Berulub OX 40 EP</b> 9011619 	Silicone oil	Polytetrafluoroethylene (PTFE)	3*	550 105	-30 200	B		Elastomer lubricant for oxygen fittings and other oxygen plant components, for oxygen pressure surges up to 20 bar at +60 °C operating temperature, e.g. in the medical sector
<b>Berulub Sihaf 1</b> 9011639 	Silicone oil	Polytetrafluoroethylene (PTFE)	1	3100 1200	-40 160	C, D, E, G		Special lubricant for lifetime lubrication, especially for plastics and elastomers, contains PTFE, certified according to ISO 21469

<sup>1)</sup> The indication refers to the unworked penetration <sup>1)</sup> Value marked in grey indicates short term maximum temperature..







Product	Base oil	Thickener	NLGI-grade	Kinematic viscosity at 40 °C /100		Description
				°C [mm <sup>2</sup> /s]	Working temperature range [°C] <sup>1)</sup>	
<b>Berulub FK 97 E</b> 9012979 	Ester	Polyurea	1*	78 12	-40 150	Lubrication and corrosion protection of lifting and sliding contacts in vehicles, for materials of copper and silver, suitable for amperage from 0.25 A to 15 A
<b>Berulub FK 80</b> 9011819 	Ester	Polyurea	0-1	78 11	-40 150	Lubrication and contact protection of electrical contact systems, good low temperature behavior, prevents sparking, resistant to water, produces smooth surfaces on non-ferrous metal, up to 30 A
<b>Berulub FK 64</b> 9012919 	Ester	Gel	1-2	78 11	-40 120 150	Lubrication and contact protection of electrical contact systems, quite suitable for low temperatures, prevents sparking, water and oxidation resistant, for currents up to 10 A
<b>Berulub FK-SU 2</b> 9011801 	Mineral oil	Bentonite	2-3*	260 20	-20 130	Contact grease to improve electric conductivity of sliding contacts and as heat sink paste in electronic components, reliable corrosion protection
<b>Berulub FK 164-2 UV</b> 9011609 	Perfluoropolyether (PFPE)	Polytetrafluoroethylene (PTFE)	2	150 45	-60 250	Lubricating paste for gold and silver plated sliding/plug-in contacts, excellent plastics/elastomer compatibility, excellent low temperature behavior
<b>Berulub FK-VPT 380</b> 9011309 	Perfluoropolyether (PFPE)	Polytetrafluoroethylene (PTFE)	-	325 30	-40 250	PTFE containing special dispersion for life-time lubrication of plug connectors, high oxidation resistance, excellent compatibility with plastics, prevents formation of impurity layers
<b>Berulub FK 33</b> 90113649 	Perfluoropolyether (PFPE)	Gel	2*	80 10	-40 180	Lubrication and protection of sliding contacts of copper, bronze and silver, protects against formation of impurity layers, no drop point, neutral to plastics and insulating materials
<b>Berulub FZ 3 HT</b> 9011229 	Perfluoropolyether (PFPE)	Metal oxides	3*	320 30	-25 250	Light-colored heat sink paste, high thermal stability, odorless, excellent insulation properties, neutral relative to conventional materials, resistant to oxidation and ageing
<b>Berulub ND-Dispersion 10</b> 6400019 	Perfluoropolyether (PFPE)	-	-	325 20	-40 250	For noise damping in automotive applications, and for protection of electrical contacts, outstanding plastic/elastomer/non-ferrous metal compatibility, very high thermal stability, excellent resistance to oxidation

<sup>1)</sup> The indication refers to the unworked penetration <sup>1)</sup> Value marked in grey indicates short term maximum temperature..

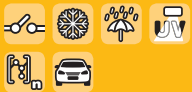
Product	Base oil	Thickener	NLGI-grade	Kinematic viscosity at 40 °C /100		Description
				°C [mm <sup>2</sup> /s]	Working temperature range [°C] 1)	
<b>Berulub FK 164 Dispersion OZF 10</b> 9013269 	Perfluoropolyether (PFPE)	–	–	–	-60 230	Contact protection, a very thin lubricating film with very low contact resistance is formed after evaporation of the solvent, suitable for mating contact of silver and gold, 1 mA up to 500 mA
<b>Berulub FK 164 Dispersion OZF 20</b> 9013299 	Perfluoropolyether (PFPE)	–	–	–	-60 230	Contact protection, a very thin lubricating film with very low contact resistance is formed after evaporation of the solvent, suitable for mating contact of silver and gold, 1 mA up to 500 mA
<b>Berutox VPT 64 Dispersion OZF 0,5</b> 9013249 	Perfluoropolyether (PFPE)	–	–	–	-40 250	Contact protection, a very thin lubricating film with very low contact resistance is formed after evaporation of the solvent, suitable for mating contact of silver and gold, 1 mA up to 500 mA
<b>Berutox VPT 64 Dispersion OZF 1</b> 9013119 	Perfluoropolyether (PFPE)	–	–	–	-40 250	Contact protection, a very thin lubricating film with very low contact resistance is formed after evaporation of the solvent, suitable for mating contact of silver and gold, 1 mA up to 500 mA
<b>Berutox VPT 64 Dispersion OZF 5</b> 9013209 	Perfluoropolyether (PFPE)	–	–	–	-40 250	Contact protection, a very thin lubricating film with very low contact resistance is formed after evaporation of the solvent, suitable for mating contact of silver and gold, 1 mA up to 500 mA
<b>Berutox VPT 64 Dispersion OZF 10</b> 9013219 	Perfluoropolyether (PFPE)	–	–	–	-40 250	Contact protection, a very thin lubricating film with very low contact resistance is formed after evaporation of the solvent, suitable for mating contact of silver and gold, 1 mA up to 500 mA
<b>Berutox VPT 64 Dispersion OZF 20</b> 9013229 	Perfluoropolyether (PFPE)	–	–	–	-40 250	Contact protection, a very thin lubricating film with very low contact resistance is formed after evaporation of the solvent, suitable for mating contact of silver and gold, 1 mA up to 500 mA
<b>Berutox VPT 64 Dispersion OZF 25</b> 9013239 	Perfluoropolyether (PFPE)	–	–	–	-40 250	Contact protection, a very thin lubricating film with very low contact resistance is formed after evaporation of the solvent, suitable for mating contact of silver and gold, 1 mA up to 500 mA
<b>Berulub FK 60</b> 9012899 	Polyalphaolefin (PAO)	Polyurea	2	30 6	-50 160	Damping grease for electrical switches, for friction partners copper/copper, copper/silver or plastic/plastic, protects against impurity layers and sparking, suitable for low temperatures

All indications and values correspond to latest knowledge and do not represent any product specification.

Product	Base oil	Thickener	NLGI-grade	Kinematic viscosity at 40 °C /100		Description
				°C [mm <sup>2</sup> /s]	Working temperature range [°C] <sup>1)</sup>	
<b>Berulub FK 125</b> 9016909 	Polyalphaolefin (PAO)	Special lithium soap	1–2	20 4	-50 120	Lubrication and contact protection, improves electrical contact, contact protection against atmospheric influences, water resistant, UV-indicator, excellent low-temperature behavior
<b>Berulub FK 35 B</b> 9012879 	Polyglycol	Bentonite	0–1*	230 45	-40 150	Lubrication and contact protection for silver-plated contact systems from 1 A to 15 A, largely neutral towards plastics/insulating materials, suitable for low temperatures, no dripping point
<b>Berulub FZ 2 S</b> 9011199 	Silicone oil	Bentonite	2–3*	75 32	-40 150	Light-colored heat sink paste, neutral towards plastics and metals, resistant to oxidation and ageing, non toxic, odorless, prevents air gaps
<b>Berulub KR-EL 2</b> 9012729 	Diester	Lithium soap	2	13 4	-50 120	Long-term lubricating grease and contact protection, forms a protective layer on copper/silver plated materials, excellent low temperature behavior, prevents formation of impurity layers, available with UV-indicator
<b>Berulub FZ 1 E 3</b> 9011219 	Synthetic ester	Bentonite, Metal oxides	2–3*	90 13	-40 150	Light-colored heat sink paste, does not contain any silicones, optimally adjusts to the surface roughness of the semiconductors and cooling elements, prevents air gaps with poor heat transfer



### Rail lubricants

Lubricants for rail-bound traffic systems are often in direct contact with the environment. The environmentally compatible, readily biodegradable rail lubricants manufactured by BECHEM fulfil or even exceed the legal requirements and are tailored to the various requirements worldwide with regard to their low temperature behaviour, sprayability and centrifugal characteristics.

Product	Base oil	Thickener	NLGI-grade	Kinematic viscosity at 40 °C /100		Description
				°C [mm <sup>2</sup> /s]	Working temperature range [°C] <sup>1)</sup>	
<b>BECHEM Ecorail EES 46</b> 8100149 	Ester	–	–	46 9	-30 90 120	Switch plate lubricating oil, oxidation and UV resistant, readily biodegradable according to OECD 301 C, DB Material No. 959 145, ideal for tramways

<sup>1)</sup> Value marked in grey indicates short term maximum temperature.. \* The indication refers to the unworked penetration





Product	Base oil		Thickener	NLGI-grade	Kinematic viscosity at 40 °C (100 °C) [mm <sup>2</sup> /s]		Description
<b>BECHEM Ecorail 2001 Plus</b> 9001081 	Synthetic oil combination	Gel	-	11 3	-30 80	Switch plate lubricant, readily biodegradable according to OECD 301 C, medium adhesion, SNCF approval No. IEM 05 004, excellent sprayability, contains light-colored solid lubricants	
<b>BECHEM Ecorail 2002</b> 6001001 	Synthetic oil combination	Gel	-	17 4	-30 80	Switch plate lubricating grease, readily biodegradable according to OECD 301 C, medium adhesion, oxidation and UV resistant, contains light-colored solid lubricants	
<b>BECHEM Ecorail 2012</b> 6400022 	Synthetic oil combination	Lithium-Calcium-Soap	000*	20 6	-30 80	Switch plate lubricating grease, readily biodegradable according to OECD 301 B, excellent adhesion even for high-speed lines, for all climatic conditions, contains solid lubricants	
<b>BECHEM Ecorail 2016</b> 6002122 	Synthetic oil combination	Lithium-Calcium-Soap	000*	20 6	-30 80	Switch plate lubricating grease, readily biodegradable according to OECD 301 B, excellent adhesion even for high-speed lines, for all climatic conditions, contains light-colored solid lubricants	
<b>BECHEM Ecorail 8200</b> 9001462 	Synthetic oil combination	Lithium-Calcium-Soap	00	35 7,5	-40 100	Wheel flange lubrication, readily biodegradable according to OECD 301 B, reliable corrosion, outstanding wear protection, high pressure accommodation capacity, good adhesion, high proportion of light-colored solid lubricants	
<b>BECHEM Ecorail 8000</b> 6001879 	Synthetic ester	Lithium soap	00-000*	50 9	-30 80	Wheel flange lubricant, readily biodegradable, in accordance with CEC L-33-A-93, flowable, without solid lubricants, resistant to oxidation, DB Material No. 526 234 for SSL-3	
<b>BECHEM Ecorail 2009</b> 6400009 	Synthetic ester	Bentonite	000*	46 9	-30 80	Switch plate lubricating grease, readily biodegradable according to OECD 301 B, excellent adhesion, contains light-colored solid lubricants	
<b>BECHEM Ecorail 5501</b> 6400059 	Synthetic ester	Lithium-Calcium-Soap	1	110 14	-55 120	Lubrication of rail systems, readily biodegradable according to OECD 301 B, contains light-colored solid lubricants and dewatering additives, high absorption of pressure and shock loads, good adhesion	
<b>BECHEM Ecorail 5502</b> 6400109 	Synthetic ester	Lithium-Calcium-Soap	2	110 14	-45 120	Lubrication of rail systems, readily biodegradable according to OECD 301 B, contains light-colored solid lubricants, high absorption of pressure loads/shock loads, good adhesion	

All indications and values correspond to latest knowledge and do not represent any product specification.



### Environmentally compatible lubricating greases

Specially selected, readily biodegradable base oils, additives and thickeners form the basis of the environmentally compatible lubricating greases made by BECHEM.

Product	Base oil	Thickener	NLGI-grade	Kinematic viscosity at 40 °C /100		Description
				°C [mm <sup>2</sup> /s]	Working temperature range [°C] <sup>1)</sup>	
<b>Berulub LE 1 X</b> 6002112 	Synthetic ester	Lithium-Calcium-Soap	1*	25 6	-40 120	High-pressure multi-purpose grease and assembly aid to break down loaded bonds of steel, stainless steel, non-ferrous metals, fast biodegradability as per OECD 301 B, good pressure-absorption capacity, good adhesion and gliding properties, noise damping
<b>Berulub ECO Super 2</b> 9001709 	Synthetic ester	Lithium-Calcium-Soap	2	110 14	-45 120	Lubricating grease for roller and plain bearings, readily biodegradable according to OECD 301 C, reliable protection against corrosion, resistant to water, contains solid lubricants
<b>Berulub ECO Super 1</b> 9001719 	Synthetic ester	Lithium-Calcium-Soap	1	110 14	-55 120	Lubricating grease for roller and plain bearings, reliable corrosion protection, resistant to water, contains dewatering additives and solid lubricants, readily biodegradable according to OECD 301 C
<b>Berugear UWS FG 34-00</b> 9001729 	Synthetic ester	Lithium-Calcium-Soap	00	320 40	-50 80	Gear lubricant for open gear drives, readily biodegradable according to OECD 301 C, excellent wear protection, excellent adhesion, very high load-carrying capacity, contains light-coloured solid lubricants



### Lubricating greases - food processing and pharmaceutical industry

Whether used as for-life lubricant for roller bearings or on plastic or elastomer materials, the BECHEM lubricating greases cover a wide range of applications and withstand the seasonal, thermal and mechanical loads of the expected operating conditions.







Product	Base oil	Thickener	NLGI-grade	Kinematic viscosity at 40 °C /100		Description
				°C [mm <sup>2</sup> /s]	Working temperature range [°C] <sup>1)</sup>	
<b>Berulub 932 Antiseize Paste</b> 2109002 	Medical white oil	Gel	1*	70 9	-40 1400	Universal screw paste, prevents cold welding and fretting corrosion, metal-free, light-colored solid lubricants, resistant to water, many acids and lyes, H1 registered

<sup>1)</sup> The indication refers to the unworked penetration <sup>1)</sup> Value marked in grey indicates short term maximum temperature..



Product	Base oil	Thickener	NLGI-grade	Kinematic viscosity at 40 °C / 100		Description
				°C [mm <sup>2</sup> /s]	Working temperature range [°C] <sup>(1)</sup>	
<b>Beruglide L</b> 9014729 	Perfluoropolyether (PFPE)	Polytetrafluoroethylene (PTFE)	1-2*	160 16	-40 190	For plastic and polymer materials, excellent resistance to oxidation/aggressive media, good noise damping properties, contains PTFE, H1 registered, halal and kosher certified, certified according to ISO 21469 
<b>Berutox VPT 54-1</b> 9013179 	Perfluoropolyether (PFPE)	Polytetrafluoroethylene (PTFE)	2	210 20	-30 230	Reduction of friction and wear at high temperatures. Can be used for all sliding speeds permitted for grease lubrication, H1 registered, halal and kosher certified, certified according to ISO 21469
<b>Berutemp 500 T 2</b> 9016709 	Perfluoropolyether (PFPE)	Polytetrafluoroethylene (PTFE)	1-2	510 45	-20 260	Long-term lubricating grease, even for vacuum, radiation, solvents and aggressive chemicals, outstanding compatibility with plastics, high thermal stability, high wear and corrosion protection, resistant to acids, bases, disinfectants, H1 registered, halal and kosher certified, certified according to ISO 21469 
<b>Berutemp 500 G 2</b> 9017109 	Perfluoropolyether (PFPE)	Gel	2	510 45	-35 260	High-temperature and long-term lubricating grease for ejector pins/slides (plastic industry) and plain bearings, compatible with plastics and elastomers, UV-indicator, H1 registered, halal and kosher certified, certified according to ISO 21469 
<b>Berulub FB 34</b> 9012269 	Polyalphaolefin (PAO)	Aluminium complex soap	1	400 40	-40 160	Synthetic universal lubricant, resistant to hot water, suitable for central lubrication systems, H1 registered, certified according to ISO 21469 
<b>Berulub FG-H 2 EP</b> 2900709 	Polyalphaolefin (PAO)	Special calcium complex soap	1-2	150 18,5	-40 160	Universal lubricant, high load-carrying properties, good adhesion and sealing effect, reliable corrosion protection and wear, resistant to ageing, water, disinfectants and cleaners, H1 registered, halal and kosher certified, certified according to ISO 21469 
<b>Berulub Sihaf 2</b> 9011309 	Silicone oil	Polytetrafluoroethylene (PTFE)	3	3100 1200	-40 160	Special lubricant for lifetime lubrication, especially for plastics and elastomers, compatible with beer froth, contains PTFE, H1 registered, halal and kosher certified, certified according to ISO 21469 
<b>Beruil FO 63</b> 9015069 	Silicone oil	Gel	1-2*	3500 1500	-50 180	Silicone lubricant for lifetime lubrication, especially for plastics and elastomers, resistant to hot and cold water, excellent high and low temperature resistance, noise damping, odorless, prevents stick-slip, contains light-colored solid lubricants, H1 registered, halal certificate
<b>Berulub FG-H 2 SL</b> 2901709 	Synthetic hydrocarbon	Special calcium complex soap	2	50 8	-45 160 200	High-performance lubricant, good adhesion and sealing properties, resistant to water and aging, reliable corrosion protection, suitable for central lubrication systems, H1 registered, Halal and Kosher certified, certified according to ISO 21469 

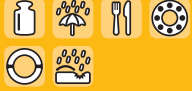



All indications and values correspond to latest knowledge and do not represent any product specification.

Product	Base oil		Thickener	NLGI-grade	Kinematic viscosity at 40 °C /100 °C [mm <sup>2</sup> /s]		Working temperature range [°C] <sup>1)</sup>	Description
<b>Berulub FA 37</b> 9011061 	White oil		Aluminium complex soap	2	67 9	-20 120	For the lubrication of roller, plain bearings and sanitary fittings, resistant to hot and cold water, transparent, H1 registered	
<b>Berulub FA 46</b> 9012791 	White oil		Aluminium complex soap	2	67 9	-20 120	For the lubrication of roller, plain bearings and sanitary fittings, resistant to hot and cold water, transparent, contains solid lubricants, increased load carrying capacity, color white, H1 registered	
<b>Berulub PV DAB 10</b> 3000201 	Mixture of paraffinic hydrocarbons		–	–	7,5	-20 45	Medically pure according to the valid Pharmacopoea Europaea and United States Pharmacopeia, colorless, transparent, absolutely odorless, H1 registered, halal and kosher certified, certified according to ISO 21469	
<b>Berulub WP 402 H1</b> 9011092 	Polybutene, White oil		Aluminium complex soap	1–2	400 30	-20 150	Long-term lubricating grease, excellent water resistance, excellent consistency-temperature behavior, high corrosion protection, EP-properties, for pellet presses (wood and animal feed industry), certified according to ISO 21469	





### Lubricating greases for the textile industry

For draw frames, autoconers or finishing – BECHEM offers special lubricating greases for roller and plain bearings with a wide temperature and load range. These lubricants are tailored to the special requirements of the corresponding production processes and, in addition, to the durability of the special machine parts.

Product	Base oil		Thickener	NLGI-grade	Kinematic viscosity at 40 °C /100 °C [mm <sup>2</sup> /s]		Working temperature range [°C] <sup>1)</sup>	Description
<b>BECHEM High-Lub LT 2 EP</b> 9004501 	Mineral oil		Lithium soap	2	180 15	-30 140	Multi-purpose EP-grease, wide application temperature range, excellent water resistance, excellent corrosion and wear protection, excellent pumpability in central lubrication systems	
<b>Beruplex HTA</b> 9006801 	Mineral oil		Aluminium complex soap	2	230 15	-25 190 200	High-temperature grease with a wide application temperature range, good corrosion protection, excellent pumpability in central lubrication systems, for dusty environments, e.g. vacuum cleaners, air motors, hot-gas blowers of tension frames (textile industry)	

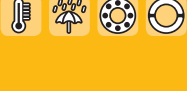
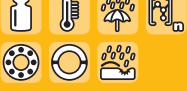

<sup>1)</sup> Value marked in grey indicates short term maximum temperature..

Product	Product		NLGI-grade	Kinematic viscosity at 40 °C (100 °C [mm <sup>2</sup> /s])		Description
	Base oil	Thickener		40 °C	100 °C	
<b>Berutox M 21 EPK</b> 9007281 	Mineral oil	Polyurea	1–2	490 32	-20 160	Multi-purpose grease for plastic/metal slide pairings, high corrosion and wear protection, good adhesion, resistant to oxidation, water, and steam, water repellent, EP-properties, e.g. for top-arm bearings and variator systems of ring spinning machines
<b>Beruplex LI-EP 2</b> 5307201 	Mineral oil	Lithium complex soap	2	180 16	-30 150	Long-term EP grease, excellent corrosion protection and wear, excellent pumpability, even under shock load, protection against high temperatures and moisture, e.g. for wheel bearings, electric motor bearings, textile industry: ring spinning rollers, underlay rollers of combing machines
<b>Berutox FB 22</b> 9012699 	Polyalphaolefin (PAO)	Barium complex soap	2	50 8	-40 180 200	For long-term lubrication at high speeds, good consistency-temperature-behavior, excellent water resistance, excellent corrosion and wear protection, good pumpability
<b>Berutemp FB 38</b> 9012619 	Polyalphaolefin (PAO)	Barium complex soap	1	160 20	-40 180	Roller and plain bearing lubrication for high loads, outdoor conditions and vibrations, suitable for low and high temperatures, reliable corrosion protection and wear, e.g. for threaded spindles, worm gears, top-arm bearings (textile industry)
<b>Beruplex RO 2</b> 9013069 	Polyalphaolefin (PAO)	Barium complex soap	2	210 25	-25 180 200	Synthetic high-performance lubricating grease for high temperatures and use in outdoor weather conditions, good pressure-absorption capacity, resistant to water and media, good corrosion and wear protection
<b>Berulub FR 43 Spray</b> 5305202 	Polyalphaolefin (PAO)	Special lithium soap	2	32 6	-50 140	For the material pairs metal/plastic and plastic/metal, excellent low temperature behavior, water-resistant and oxidation resistant, contains PTFE, e.g. for the lubrication of lock mechanisms of package holders (textile industry)
<b>BEICHEM Premium 0</b> 9003532 	Mineral oil	Lithium-Calcium-Soap	0	90 10	-30 130	For central lubrication systems of looms, allows extended re-lubrication intervals, good corrosion protection
<b>Berutox M 21 KN</b> 9007601 	Mineral oil	Polyurea	1–2	490 32	-20 180	Long-term lubricating grease, outstanding consistency-temperature-behavior, excellent resistance to water, excellent corrosion and wear protection, EP-properties
<b>Berutox FH 28 KN</b> 9013629 	Polyalphaolefin (PAO)	Polyurea	1–2	400 40	-30 180 200	Synthetic long-term lubricating grease, outstanding consistency-temperature behavior, excellent chemical and water resistance, excellent corrosion and wear protection, EP-properties, H2 registered, e.g. for bearing lubrication of dryer cylinders

↓ Textile weaving

↓ Textile sizing

All indications and values correspond to latest knowledge and do not represent any product specification.

Product	Base oil	Thickener	NLGI-grade	Kinematic viscosity at 40 °C /100 °C [mm <sup>2</sup> /s]		Working temperature range [°C] <sup>1)</sup>	Description
				230	15		
<b>Beruplex HTA</b> 9006801 	Mineral oil	Aluminium complex soap	2	230	-25 190 200	High-temperature grease with a wide application temperature range, good corrosion protection, excellent pumpability in central lubrication systems, for dusty environments, e.g. vacuum cleaners, air motors, hot-gas blowers of tension frames (textile industry)	

Textile processing

<sup>1)</sup> Value marked in grey indicates short term maximum temperature..



All indications and values correspond to latest knowledge and do not represent any product specification.



# Lubricating oils

Whether as hydraulic fluid, gear oil or H1-registered chain oil – for various industrial applications BECHEM offers a range of products which significantly contributes to a modern production and manufacturing technology as well as service and maintenance.

The production program ranges from high-quality, mineral oil based products up to extremely high-performance synthetic oils. In addition these oils will extend re-lubrication intervals and reduced downtime, often contributing to a reduction in the variety of products in use and thus a reduction in costs.

- **Hydraulic fluids**
- **Gear and circulation oils**
- **Chain oils**
- **Silicone oils**
- **Environmentally compatible lubricating oils**
- **Lubricating oils - food and pharmaceutical industry**
- **Lubricating oils for the textile industry**

## CORE RANGE

Ask about our local custom solutions



## Hydraulic fluids

BECHEM hydraulic fluids reduce friction and wear at high thermal loads. Special additives prevent corrosion even in case of extreme loads. For the mining industry BECHEM offers flame-resistant products which are suitable for heavy duty conditions and guarantee the perfect functioning of the hydraulic systems.

Product	Base oil	Kinematic viscosity at 40 °C [mm <sup>2</sup> /s]		Viscosity index	Pourpoint [°C]	Flash point approx. [°C]	Standards	Description according to DIN	Description
		32	105						
<b>BECHEM Hydrostar 32 D</b> 1202102 	Mineral oil	32	105	-33	≥ 220	DIN 51524-2	HLPD	Hydraulic oil, dispersing/detergent, high thermal stability and resistance to oxidation, excellent protection against wear and corrosion, absorbs up to 2% water, free of zinc	
<b>BECHEM Hydrostar 46 D</b> 0801202 	Mineral oil	46	98	-33	≥ 220	DIN 51524-2	HLPD	Hydraulic oil, dispersing/detergent, high thermal stability and resistance to oxidation, excellent protection against wear and corrosion, absorbs up to 2% water, free of zinc	
<b>BECHEM Hydrostar 68 D</b> 1200502 	Mineral oil	68	100	-33	≥ 220	DIN 51524-2	HLPD	Hydraulic oil, dispersing/detergent, high thermal stability and resistance to oxidation, excellent protection against wear and corrosion, absorbs up to 2% water, free of zinc	
<b>BECHEM Hydrostar HEP 22</b> 9259809 	Ester	22	175	-24	≥ 250	DIN ISO 15380	HEP	Hydraulic oil based on synthetic ester, readily biodegradable, complies with ISO 15380	
<b>BECHEM Hydrostar HEP 32</b> 9258809 	Ester	32	193	-27	≥ 260	DIN ISO 15380	HEP	Hydraulic oils based on synthetic ester, complies with ISO 15380, readily biodegradable according to OECD 301 B	
<b>BECHEM Hydrostar HEP 46 EEL</b> 9258709 	Ester	46	170	-42	≥ 270	DIN ISO 15380, VDMA 24568	HEP	Hydraulic oil based on synthetic ester, readily biodegradable according to OECD 301 B, complies with ISO 15380, VDMA 24568, SS 15 54 34	
<b>BECHEM Hydrostar HY 46 Red</b> 4506109 	Water-glycol	48	206	-	-	7. Lux Bericht, ISO 12922, VDMA 24317	HFC	Flame retardant hydraulic fluid based on water-glycol, recommended operating temperature +30 °C to +50 °C, nitrite-free	
<b>BECHEM Hydrostar TE 68 S</b> 9262909 	Ester	68	180	-30	≥ 300	7. Lux Bericht, DIN EN ISO 15029-1, DIN ISO 15380, VDMA 24568	HEP, HFD-U	Flame retardant, water-free hydraulic fluid, extended oil service life, quickly biodegradable according to OECD 301 B, meets DIN ISO 15380 and VDMA 24568 requirements	

Media for oil-hydraulic systems



Product	Base oil	Kinematic viscosity at 40 °C [mm²/s]				Standards	Description according to DIN	
		Viscosity index	Pourpoint [°C]	Flash point approx. [°C]	Description			
<b>BECEM Staroil HVI 46</b> 0802002 	Mineral oil	46	150	-39	≥ 220	DIN 51524-3	HVLP	Hydraulic oil, increased viscosity index, excellent corrosion protection and wear, thermal stability, resistant to oxidation, good air and water separation, compatible with seals
<b>BECEM Staroil NR 10</b> 0800902 	Mineral oil	10	95	-24	≥ 150	DIN 51524-2	HLP	Hydraulic oil with high thermal stability and resistance to oxidation, excellent protection against wear and corrosion, excellent air and water separation capacity as well as outstanding viscosity/temperature behavior, free of zinc
<b>BECEM Staroil NR 22</b> 0800202 	Mineral oil	22	95	-30	≥ 190	DIN 51524-2	HLP	Hydraulic oil with high thermal stability and resistance to oxidation, excellent protection against wear and corrosion, excellent air and water separation capacity as well as outstanding viscosity/temperature behavior, free of zinc
<b>BECEM Staroil NR 32</b> 0800302 	Mineral oil	32	95	-30	≥ 200	DIN 51524-2	HLP	Hydraulic oil with high thermal stability and resistance to oxidation, excellent protection against wear and corrosion, excellent air and water separation capacity as well as outstanding viscosity/temperature behavior, free of zinc
<b>BECEM Staroil NR 46</b> 0800502 	Mineral oil	46	95	-27	≥ 215	DIN 51524-2	HLP	Hydraulic oil with high thermal stability and resistance to oxidation, excellent protection against wear and corrosion, excellent air and water separation capacity as well as outstanding viscosity/temperature behavior, free of zinc
<b>BECEM Staroil NR 68</b> 0800702 	Mineral oil	68	95	-24	≥ 230	DIN 51524-2	HLP	Hydraulic oil with high thermal stability and resistance to oxidation, excellent protection against wear and corrosion, excellent air and water separation capacity as well as outstanding viscosity/temperature behavior, free of zinc
<b>BECEM Fimitol P 87 AF</b> 9612262 	Mineral oil	-	-	-	-	7. Lux Bericht, RAG N 762 830	HFAE	Flame retardant water miscible hydraulic concentrate for longwall mining, good corrosion protection, best biostability
<b>BECEM Starlit EM-MA-DF</b> 9401339 	-	-	-	-	-	TRGS 611	HFAS	Flame retardant, water miscible concentrate and forming agent, stable solution, optimal biostability

↓ Media for waterhydraulic systems











## Gear and circulation oils

High-performance gear and circulation oils made by BECHEM fulfil the requirements of wear protection even with high mechanical and dynamic loads.

Product	Base oil	Kinematic viscosity at 40 °C [mm <sup>2</sup> /s]					Standards	Description according to DIN	
		Viscosity index	Pourpoint [°C]	Flash point approx. [°C]	Description	Description			
<b>BECHEM Ovitol KT 100 S</b> 9512501 	Mineral oil	100	94	-15	≥ 230	–	CL	Machine and circulating oil for flood lubricated bearings in rolling mills, outstanding water separation capacity and corrosion protection, excellent resistance to ageing	
<b>BECHEM Ovitol KT 220 S</b> 9512601 	Mineral oil	220	94	-12	≥ 230	–	CL	Machine and circulating oil for flood lubricated bearings in rolling mills, outstanding water separation capacity and corrosion protection, excellent resistance to ageing	
<b>BECHEM Ovitol KT 460 S</b> 9515401 	Mineral oil	460	94	-9	≥ 230	–	CL	Machine and circulating oil for flood lubricated bearings in rolling mills, outstanding water separation capacity and corrosion protection, excellent resistance to ageing	
<b>BECHEM Staroil G 100</b> 9551601 	Mineral oil	100	100	-33	≥ 235	DIN 51517-3	CLP	High-performance gear oil for spur, bevel, planetary and worm gears, excellent wear protection, very high ageing resistance, good load-carrying capacity and viscosity/temperature behavior, excellent water and air separation capacity	
<b>BECHEM Staroil G 150</b> 9551701 	Mineral oil	150	95	-27	≥ 230	DIN 51517-3	CLP	High-performance gear oil for spur, bevel, planetary and worm gears, excellent wear protection, very high ageing resistance, good load-carrying capacity and viscosity/temperature behavior, excellent water and air separation capacity	
<b>BECHEM Staroil G 220</b> 9551901 	Mineral oil	220	100	-26	≥ 230	DIN 51517-3	CLP	High-performance gear oil for spur, bevel, planetary and worm gears, excellent wear protection, very high ageing resistance, good load-carrying capacity and viscosity/temperature behavior, excellent water and air separation capacity	
<b>BECHEM Staroil G 320</b> 9553501 	Mineral oil	320	95	-18	≥ 230	DIN 51517-3	CLP	High-performance gear oil for spur, bevel, planetary and worm gears, excellent wear protection, very high ageing resistance, good load-carrying capacity and viscosity/temperature behavior, excellent water and air separation capacity	
<b>BECHEM Staroil G 460</b> 9554501 	Mineral oil	460	95	-18	≥ 270	DIN 51517-3	CLP	High-performance gear oil for spur, bevel, planetary and worm gears, excellent wear protection, very high ageing resistance, good load-carrying capacity and viscosity-temperature-behavior, excellent water and air separation capacity	

Product	Base oil	Kinematic viscosity at 40 °C [mm <sup>2</sup> /s]				Standards	Description according to DIN	Description
		Viscosity index	Pourpoint [°C]	Flash point approx. [°C]				
<b>BECEM Staroil G 680</b> 9555501 	Mineral oil	680	95	-18	≥ 260	DIN 51517-3	CLP	High-performance gear oil for spur, bevel, planetary and worm gears, excellent wear protection, very high ageing resistance, good load-carrying capacity and viscosity-temperature behavior, excellent water and air separation capacity
<b>BECEM Staroil SMO 68</b> 9251108 	Mineral oil	68	100	-33	≥ 210	DIN 51517-3	CLPF	High-performance gear oils for heavy-duty gear units with high contact pressure or shock loads, good load-carrying capacity, excellent wear protection, good viscosity-temperature behavior, very high ageing resistance, excellent water and air separation capacity
<b>BECEM Staroil SMO 150</b> 9251201 	Mineral oil	150	95	-33	≥ 220	DIN 51517-3	CLPF	High-performance gear oil for heavy-duty gear units with high flank pressures and shock loads, good load-carrying capacity and excellent wear protection, good viscosity/temperature behavior, very high ageing resistance, excellent water and air separation capacity
<b>BECEM Staroil SMO 220</b> 9251301 	Mineral oil	220	95	-20	≥ 230	DIN 51517-3	CLPF	High-performance gear oil for heavy-duty gear units with high flank pressures and shock loads, good load-carrying capacity and excellent wear protection, good viscosity/temperature behavior, very high ageing resistance, excellent water and air separation capacity
<b>BECEM Staroil SMO 320</b> 9252201 	Mineral oil	320	95	-20	≥ 250	DIN 51517-3	CLPF	High-performance gear oil for heavy-duty gear units with high flank pressures and shock loads, good load-carrying capacity and excellent wear protection, good viscosity/temperature behavior, very high ageing resistance, excellent water and air separation capacity
<b>BECEM Staroil SMO 460</b> 9251401 	Mineral oil	460	95	-9	≥ 230	DIN 51517-3	CLPF	High-performance gear oil for heavy-duty gear units with high flank pressures and shock loads, good load-carrying capacity and excellent wear protection, good viscosity/temperature behavior, very high ageing resistance, excellent water and air separation capacity
<b>BECEM Staroil SMO 680</b> 9251708 	Mineral oil	680	100	-15	≥ 230	DIN 51517-3	CLPF	High-performance gear oil for heavy-duty gear units with high flank pressures and shock loads, good load-carrying capacity and excellent wear protection, good viscosity/temperature behavior, very high ageing resistance, excellent water and air separation capacity
<b>BECEM Staroil SMO 1500</b> 9252402 	Mineral oil	1350	90	-10	≥ 230	DIN 51517-3	CLPF	High-performance gear oils for heavy-duty gear units with high contact pressure or shock loads, good load-carrying capacity, excellent wear protection, good viscosity-temperature behavior, very high ageing resistance, excellent water and air separation capacity
<b>Berugear GS 68 BM</b> 9552112 	Mineral oil	68	100	-30	≥ 210	DIN 51517-3	CLP	High-performance oil for heavy-duty gears, contains PD-additives, excellent wear protection, very high resistance to micropitting, forms reactive surface layer that supports plastic deformation and thus increases the contact area

All indications and values correspond to latest knowledge and do not represent any product specification.

Product	Base oil	Kinematic viscosity at 40 °C [mm <sup>2</sup> /s]				Standards	Description according to DIN	Description
		Viscosity index	Pourpoint [°C]	Flash point approx. [°C]				
<b>Berugear GS 150 BM</b> 9551401 	Mineral oil	151	99	-24	≥ 240	DIN 51517-3	CLP	High-performance oil for heavy-duty gears, contains PD-additives, excellent wear protection, very high resistance to micropitting, forms reactive surface layer that supports plastic deformation and thus increases the contact area
<b>Berugear GS 320 BM</b> 9553602 	Mineral oil	334	97	-21	≥ 270	DIN 51517-3	CLP	High-performance oil for heavy-duty gears, contains PD-additives, excellent wear protection, very high resistance to micropitting, forms reactive surface layer that supports plastic deformation and thus increases the contact area
<b>Berugear GS 460 BM</b> 9554602 	Mineral oil	474	95	-15	≥ 265	DIN 51517-3	CLP	High-performance oil for heavy-duty gears, contains PD-additives, excellent wear protection, very high resistance to micropitting, forms reactive surface layer that supports plastic deformation and thus increases the contact area
<b>Berugear GS 680 BM</b> 9554702 	Mineral oil	738	92	-15	≥ 290	DIN 51517-3	CLP	High-performance oil for heavy-duty gears, contains PD-additives, excellent wear protection, very high resistance to micropitting, forms reactive surface layer that supports plastic deformation and thus increases the contact area
<b>Berugear HV 10</b> 9553402 	Mineral oil, Synthetic oil	10000	175	-12	≥ 150	-	-	High-performance fluid with extremely high base oil viscosity for open and slow-running closed gear units, excellent wear protection, very high load-carrying capacity, excellent adhesion
<b>Berugear HV 20</b> 9553402 	Mineral oil, Synthetic oil	18500	180	-15	≥ 160	-	-	High-performance fluid with extremely high base oil viscosity for open and slow-running closed gear units, excellent wear protection, very high load-carrying capacity, excellent adhesion
<b>Berusynth EP 68</b> 9590019 	Polyglycol	68	201	-42	≥ 240	DIN 51517-3	CLP PG	High-performance gear oil on polyglycol basis for heavy-duty spur, bevel, planetary and worm gears, allows extended oil changing intervals, excellent wear protection, very high ageing resistance, reduces tooth friction losses in the gear unit
<b>Berusynth EP 100</b> 9590079 	Polyglycol	100	203	-42	≥ 240	DIN 51517-3	CLP PG	High-performance gear oil on polyglycol basis for heavy-duty spur, bevel, planetary and worm gears, allows extended oil changing intervals, excellent wear protection, very high ageing resistance, reduces tooth friction losses in the gear unit
<b>Berusynth EP 150</b> 9590069 	Polyglycol	150	196	-39	≥ 240	DIN 51517-3	CLP PG	High-performance gear oil on polyglycol basis for heavy-duty spur, bevel, planetary and worm gears, allows extended oil changing intervals, excellent wear protection, very high ageing resistance, reduces tooth friction losses in the gear unit

Product	Base oil	Kinematic viscosity at 40 °C [mm <sup>2</sup> /s]					Standards	Description according to DIN	
		Viscosity index	Pourpoint [°C]	Flash point approx. [°C]	Description	Description			
<b>Berulyth EP 220</b> 9590049 	Polyglycol	220	198	-33	≥ 250	DIN 51517-3	CLP PG	High-performance gear oil on polyglycol basis for heavy-duty spur, bevel, planetary and worm gears, allows extended oil changing intervals, excellent wear protection, very high ageing resistance, reduces tooth friction losses in the gear unit	
<b>Berulyth EP 320</b> 9590109 	Polyglycol	320	212	-33	≥ 250	DIN 51517-3	CLP PG	High-performance gear oil on polyglycol basis for heavy-duty spur, bevel, planetary and worm gears, allows extended oil changing intervals, excellent wear protection, very high ageing resistance, reduces tooth friction losses in the gear unit	
<b>Berulyth EP 460</b> 9590059 	Polyglycol	460	231	-33	≥ 250	DIN 51517-3	CLP PG	High-performance gear oil on polyglycol basis for heavy-duty spur, bevel, planetary and worm gears, allows extended oil changing intervals, excellent wear protection, very high ageing resistance, reduces tooth friction losses in the gear unit	
<b>Berulyth EP 680</b> 9590119 	Polyglycol	680	245	-30	≥ 250	DIN 51517-3	CLP PG	High-performance gear oil on polyglycol basis for heavy-duty spur, bevel, planetary and worm gears, allows extended oil changing intervals, excellent wear protection, very high ageing resistance, reduces tooth friction losses in the gear unit	
<b>Berulyth EP 1000</b> 9590209 	Polyglycol	1000	278	-30	≥ 280	DIN 51517-3	CLP PG	High-performance gear oil on polyglycol basis for heavy-duty spur, bevel, planetary and worm gears, allows extended oil changing intervals, excellent wear protection, very high ageing resistance, reduces tooth friction losses in the gear unit	
<b>Berulyth GP 68</b> 9351409 	Polyalphaolefin (PAO)	67	155	-60	≥ 275	DIN 51517-3	CLP HC	High-performance gear oil on polyalphaolefin basis for heavy-duty spur, bevel, planetary and worm gear units, allows extended oil changing intervals, excellent wear protection, very high ageing resistance, miscible with mineral oil	
<b>Berulyth GP 150</b> 9351509 	Polyalphaolefin (PAO)	143	155	-45	≥ 265	DIN 51517-3	CLP HC	High-performance gear oil on polyalphaolefin basis for heavy-duty spur, bevel, planetary and worm gear units, enables extended oil changing intervals, excellent wear protection, very high ageing resistance, miscible with mineral oil	
<b>Berulyth GP 220</b> 9351609 	Polyalphaolefin (PAO)	235	145	-42	≥ 250	DIN 51517-3	CLP HC	High-performance gear oil on polyalphaolefin basis for heavy-duty spur, bevel, planetary and worm gear units, enables extended oil changing intervals, excellent wear protection, very high ageing resistance, miscible with mineral oil	
<b>Berulyth GP 320</b> 9351709 	Polyalphaolefin (PAO)	316	145	-40	≥ 280	DIN 51517-3	CLP HC	High-performance gear oil on polyalphaolefin basis for heavy-duty spur, bevel, planetary and worm gear units, enables extended oil changing intervals, excellent wear protection, very high ageing resistance, miscible with mineral oil	

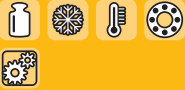
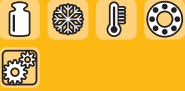

All indications and values correspond to latest knowledge and do not represent any product specification.





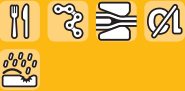

Product	Base oil	Kinematic viscosity at 40 °C [mm <sup>2</sup> /s]				Pourpoint [°C]	Flash point approx. [°C]	Standards	Description according to DIN	Description
<b>Beresynt GP 460</b> 9351809 	Polyalphaolefin (PAO)	440	155	-39	≥ 245	DIN 51517-3	CLP HC	High-performance gear oil on polyalphaolefin basis for heavy-duty spur, bevel, planetary and worm gear units, enables extended oil changing intervals, excellent wear protection, very high ageing resistance, miscible with mineral oil		
<b>Beresynt GP 1000</b> 9351909 	Polyalphaolefin (PAO)	1007	165	-27	≥ 250	DIN 51517-3	CLP HC	High-performance gear oil on polyalphaolefin basis for heavy-duty spur, bevel, planetary and worm gear units, enables extended oil changing intervals, excellent wear protection, very high ageing resistance, miscible with mineral oil		

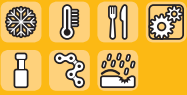
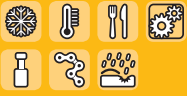
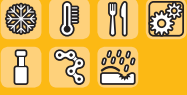

### Chain oils

High-performance gear and circulation oils made by BECHEM fulfil the requirements of wear protection even with high mechanical and dynamic loads.

Product	Base oil	Kinematic viscosity at 40 °C [mm <sup>2</sup> /s]				Pourpoint [°C]	Flash point approx. [°C]	Description
<b>BECHEM ECO Fluid CS 120</b> 9453209 	Native oil	49	190	-21	≥ 290	Chain saw oil, good adhesion, fulfils the requirements of the KWF (Kuratorium für Waldarbeit- und Forsttechnik e. V.)		
<b>Berudraw 3985</b> 3700909 	Native ester	250	90	-30	≥ 230	Mineral oil free drawing and chain oil on native ester basis, high lubricating capacity, allows optimal individual deformations in forming operations, ideal for the lubrication of proofing cabinet chains in industrial bakeries, Halal certified, Kosher certified, H1-registered, certified according to ISO 21469		
<b>Berulit IKP</b> 9012408 	Mineral oil	115	-	-36	190	Chain oil to lubricate slow-moving transport and conveyor chains with large chain links, high load-carrying capacity, low dust binding, excellent wear and corrosion protection, contains graphite		
<b>Beresynt 15 H1</b> 9362219 	Polyalphaolefin (PAO)	15	125	-65	170	High-performance oil for circulation lubrication and for transport chains, hydraulic equipment, gear units, blowers, air compressors, effective corrosion and wear protection, neutral to conventional seals and paints, odorless and taste, H1-registered, halal and kosher certified, certified according to ISO 21469		









Product	Base oil	Kinematic viscosity at 40 °C [mm <sup>2</sup> /s]				Flash point approx. [°C]	Description
		32	140	Viscosity index	Pourpoint [°C]		
<b>Beresynt 32 H1</b> 9362419 	Polyalphaolefin (PAO)	32	140	-65	≥ 220	High-performance oil for circulation lubrication and for transport chains, hydraulic equipment, gear units, blowers, air compressors, effective corrosion and wear protection, neutral to conventional seals and paints, odorless and taste, H1-registered, halal and kosher certified, certified according to ISO 21469	
<b>Beresynt 46 H1</b> 9362229 	Polyalphaolefin (PAO)	46	140	-60	≥ 240	High-performance oil for circulation lubrication and for transport chains, hydraulic equipment, gear units, blowers, air compressors, effective corrosion and wear protection, neutral to conventional seals and paints, odorless and taste, H1-registered, halal and kosher certified, certified according to ISO 21469	
<b>Beresynt 68 H1</b> 9362239 	Polyalphaolefin (PAO)	68	145	-55	≥ 240	High-performance oil for circulation lubrication and for transport chains, hydraulic equipment, gear units, blowers, air compressors, effective corrosion and wear protection, neutral to conventional seals and paints, odorless and taste, H1-registered, halal and kosher certified, certified according to ISO 21469	
<b>Beresynt 100 H1</b> 9362249 	Polyalphaolefin (PAO)	100	145	-50	≥ 250	High-performance oil for circulation lubrication and for transport chains, hydraulic equipment, gear units, blowers, air compressors, effective corrosion and wear protection, neutral to conventional seals and paints, odorless and taste, H1-registered, halal and kosher certified, certified according to ISO 21469	
<b>Beresynt 150 H1</b> 9362239 	Polyalphaolefin (PAO)	150	145	-50	≥ 250	High-performance oil for circulation lubrication and for transport chains, hydraulic equipment, gear units, blowers, air compressors, effective corrosion and wear protection, neutral to conventional seals and paints, odorless and taste, H1-registered, halal and kosher certified, certified according to ISO 21469	
<b>Beresynt 220 H1</b> 9362259 	Polyalphaolefin (PAO)	220	150	-50	≥ 250	High-performance oil for circulation lubrication and for transport chains, hydraulic equipment, gear units, blowers, air compressors, effective corrosion and wear protection, neutral to conventional seals and paints, odorless and taste, H1-registered, halal and kosher certified, certified according to ISO 21469	
<b>Beresynt 320 H1</b> 9362349 	Polyalphaolefin (PAO)	320	150	-45	≥ 250	High-performance oil for circulation lubrication and for transport chains, hydraulic equipment, gear units, blowers, air compressors, effective corrosion and wear protection, neutral to conventional seals and paints, odorless and taste, H1-registered, halal and kosher certified, certified according to ISO 21469	
<b>Beresynt 460 H1</b> 9362269 	Polyalphaolefin (PAO)	460	150	-40	≥ 255	High-performance oil for circulation lubrication and for transport chains, hydraulic equipment, gear units, blowers, air compressors, effective corrosion and wear protection, neutral to conventional seals and paints, odorless and taste, H1-registered, halal and kosher certified, certified according to ISO 21469	
<b>Beresynt 680 H1</b> 9362279 	Polyalphaolefin (PAO)	680	155	-35	≥ 260	High-performance oil for circulation lubrication and for transport chains, hydraulic equipment, gear units, blowers, air compressors, effective corrosion and wear protection, neutral to conventional seals and paints, odorless and taste, H1-registered, halal and kosher certified, certified according to ISO 21469	

All indications and values correspond to latest knowledge and do not represent any product specification.

Product	Base oil	Kinematic viscosity at 40 °C [mm <sup>2</sup> /s]			Flash point approx. [°C]	Description
		Viscosity Index	Pourpoint [°C]	Flash point approx. [°C]		
<b>Berulyth 1000 H1</b> 9362289 	Polyalphaolefin (PAO)	1000	165	-35	≥ 260	High-performance oil for circulation lubrication and for transport chains, hydraulic equipment, gear units, blowers, air compressors, effective corrosion and wear protection, neutral to conventional seals and paints, odorless and taste, H1-registered, halal and kosher certified, certified according to ISO 21469
<b>Berulyth CA 100</b> 9306109 	Ester	100	110	-48	≥ 260	High-performance chain oil for chains in drying ovens in paint shops, compatible with paint, no critical formation of residues, low evaporation rate even at high temperatures
<b>Berulyth CB 180 H1</b> 9303609 	Ester	180	145	-45	≥ 235	High-temperature chain oil, wide application temperature range, excellent wetting and creeping properties, resistant to hot and cold water, good corrosion protection, no critical formation of residues, H1 registered, halal and kosher certified, certified according to ISO 21469
<b>Berulyth CC 100</b> 9305909 	Synthetic oil	100	133	-39	-	High-performance chain oil developed for cleaning purposes during operation, outstanding cleaning effect, suitable for automatic lubrication systems, adjusted to the Berulyth product series CU and CW
<b>Berulyth CF 250</b> 9307009 	Ester	250	115	-40	≥ 250	High-temperature chain oil for film stretching machines, compatibility with plastics, especially PP-foils, low evaporation rate even at high temperatures, compatible with copper
<b>Berulyth CG 370 H1</b> 9303109 	Polyglycol	-	230	-	≥ 200	Synthetic high-temperature chain oil, at +200 °C effective as fluid lubricant, at higher temperatures the synthetic carrier fluid evaporates without leaving any residues, the remaining dry lubricating film guarantees reliable lubrication at temperatures up to +650 °C, H1 registered
<b>Berulyth CP 20</b> 9012661 	Ester	13,5	-	-63	180	Low-temperature chain oil, effective corrosion and wear protection, good dry running properties through solid lubricant content, pumpable up to -55 °C, sprayable in oil-air-systems
<b>Berulyth CP 73</b> 9012509 	Polyglycol	-	-	-45	200	High-temperature chain oil, wide application temperature range, good corrosion protection, reduces wear, good dry-run properties, no tendency to critical formation of residues, good creeping and penetration capability
<b>Berulyth CP 80</b> 5500701 	Mineral oil	-	-	-	-	Chain lubricant for extended lubrication intervals in outdoor applications, excellent adhesion after evaporation of the solvent, good dry-running properties based on solid lubricant MoS <sub>2</sub>





Product	Base oil	Kinematic viscosity at 40 °C [mm <sup>2</sup> /s]				Flash point approx. [°C]	Description
		54	120	Viscosity index	Pourpoint [°C]		
<b>Berusynth CU 46</b> 9306209 	Ester	54	120	-51	≥ 260	Fully synthetic high-performance chain oil, excellent penetration capability, good corrosion protection, also suitable for high temperatures, low evaporation rate and dust binding, adapted for Berusynth CC 100, H2 registered	
<b>Berusynth CU 100</b> 9306309 	Ester	100	115	-42	≥ 260	High-temperature chain oil, wide temperature range, good wetting and creeping properties, hot/cold water resistant, good corrosion protection, no formation of critical residues, adjusted to Berusynth CC 100 H2-registered, Halal certified, Kosher certified, ISO 21469 certified	
<b>Berusynth CU 250</b> 9306509 	Ester	250	120	-45	≥ 250	High-temperature chain oil, wide application temperature range, excellent wetting and creeping properties, hot and cold water resistant, good corrosion protection, no formation of critical residues, H2-registered, adjusted to Berusynth CC 100 	
<b>Berusynth CU 3000</b> 9306709 	Ester	3000	170	-27	≥ 250	High-performance chain oil for long-term lubrication, excellent wash-out stability, excellent corrosion and wear protection, extremely adhesive even at high centrifugal forces, manual application only, adjusted to Berusynth CC 100 	
<b>Berusynth CW 280</b> 9306009 	Ester	280	160	-40	≥ 260	High-temperature chain oil to lubricate the roller systems and belts of continuous double belt presses (chip board production), very low evaporation rate in the total high temperature range	
<b>Berusynth H1 Spray</b> 5301419 	Polyalphaolefin (PAO)	100	140	-	-	Transparent chain oil/adhesive oil, good corrosion and wear protection, high load-carrying capacity, solvent free, H1-registered 	

All indications and values correspond to latest knowledge and do not represent any product specification.



## Silicone oils





















In view of their excellent chemical, physical and physiological properties, the BECHEM silicone oils can be used for various applications, e.g. as lubricating and antiseize agent, for surface treatment and as dielectric liquid.

Product	Base oil	Kinematic viscosity at 40 °C [mm <sup>2</sup> /s]	Viscosity index		Flash point approx. [°C]	Description
			Pourpoint [°C]	Flash point approx. [°C]		
<b>Beruil P 140 Spray</b> 5304409 	Silicone oil	260	-	-	-	Suitable for non-ferrous metals, plastics and elastomers, extremely low evaporation losses in high temperature range, physiologically harmless, neutral in odor and taste, H1 registered
<b>Beruil SM 50</b> 2201209 	Polydimethylsiloxane	40	-	-52	≥ 250	Silicone oil, wide application temperature range, excellent plastics and elastomer compatibility, good wetting behavior, thermal stability and oxidation stability
<b>Beruil SM 350</b> 2200609 	Silicone oil	270	-	-47	≥ 300	Silicone oil, physiologically harmless, wide application temperature range, excellent plastics and elastomer compatibility, good wetting behavior, thermal stability and oxidation stability, H1-registered, halal and kosher certified
<b>Beruil SM 2000</b> 9256909 	Polydimethylsiloxane	2000	-	60	≥ 250	For plastic bearings and gears which require a high base oil viscosity, high viscosity index, resistant towards water, H1 registered



### Environmentally compatible lubricating oils

The biodegradable lubricating oils made by BECHEM are environmentally friendly and help to conserve resources. The ageing resistant products are characterised by optimum lubricating performance.

Product	Base oil	Kinematic viscosity at 40 °C /100 °C [mm <sup>2</sup> /s]		Viscosity index	Working temperature range [°C]	Pourpoint [°C]	Flash point approx. [°C]	Description according to DIN	Description
<b>BECHEM Hydrostar HEES 46 EEL</b> 9251009   	Synthetic ester	46 9	160	-30 90 120	-45	≥ 250	HEES	High-performance synthetic ester based hydraulic oil, readily biodegradable according to OECD 301 B, complies with ISO 15380, VDMA 24568, SS 15 54 34, EU Ecolabel, other viscosities on request	↓ Hydraulic fluids
<b>BECHEM Hydrostar HEP 22</b> 9259809   	Ester	22 6	175	-20 90 120	-24	≥ 250	HEP	Hydraulic oil based on synthetic ester, readily biodegradable, complies with ISO 15380	
<b>BECHEM Hydrostar HEP 32</b> 9258809   	Ester	32 7	193	-25 90 120	-27	≥ 260	HEP	Hydraulic oils based on synthetic ester, complies with ISO 15380, readily biodegradable according to OECD 301 B	
<b>BECHEM Hydrostar HEP 46 EEL</b> 9258709   	Ester	46 9	170	-30 90 120	-42	≥ 270	HEP	Hydraulic oil based on synthetic ester, readily biodegradable according to OECD 301 B, complies with ISO 15380, VDMA 24568, SS 15 54 34	
<b>BECHEM Hydrostar TE 68 S</b> 9262909    	Ester	68 13	180	-30 90 120	-30	≥ 300	HEP, HFD-U	Flame retardant, water-free hydraulic fluid, extended oil service life, quickly biodegradable according to OECD 301 B, meets DIN ISO 15380 and VDMA 24568 requirements	
<b>BECHEM ECO Fluid CS 120</b> 9453209  	Native oil	49 10	190	-15 120	-21	≥ 290	-	Chain saw oil, good adhesion, fulfils the requirements of the KWF (Kuratorium für Waldarbeit- und Forsttechnik e. V.)	↓ Various
<b>Berulit ECO S 5</b> 1504309  	Polyglycol, Water	- -	-	-40 60	-45	-	-	Acid and resin free oil to lubricate pneumatic tools, application temperature range from -40 °C to +60 °C, good corrosion protection and wear	

All indications and values correspond to latest knowledge and do not represent any product specification.







## Lubricating oils - food and pharmaceutical industry

BEICHEM offers high-performance food grade lubricating oils. The mineral oil and ester-free Berusynth H 1 product series meets the requirements of the machine manufacturers as well as the relevant DIN and ISO standards. Berusynth H 1 products excel in their extremely long service life, they are miscible and also compatible with residual quantities of conventional, mineral-oil based lubricants.

Product	Base oil	Kinematic viscosity at 40 °C [mm <sup>2</sup> /s]	Viscosity index	Pourpoint [°C]	Flash point approx. [°C]	Description according to DIN	Description
<b>BEICHEM Fluid SD</b> 2101412 	-	-	-	-	-	-	Special lubricant and solvent to solvate and dissolve sugar crusts and caramel, for the lubrication of machine parts that are exposed to sugar, sugar dusts and liquids with sugar content, eliminates formation of crusts, tasteless and odorless, H1-registered, Halal certified
<b>BEICHEM Fluid W 68-3H</b> 8100152 	Medical white oil	70	-	-9	≥ 220	-	Parting agent and lubricating agent for direct contact with foodstuffs, odorless and tasteless, good corrosion protection, free from animal ingredients, genetically modified ingredients and nut oils, 3H certified, Halal certified
<b>BEICHEM Fluid W 68-3H Spray</b> 5301112 	Medical white oil	68	-	-	-	-	Parting agent and lubricating agent for direct contact with foodstuffs, odorless and tasteless, good corrosion protection, free from animal ingredients, genetically modified ingredients and nut oils, 3H certified
<b>BEICHEM Plantfluid</b> 3702709 	Native oils	42	-	-12	≥ 320	E	High-temperature lubricant for continuous ovens, transparent, reliable corrosion protection, eliminates squeaking noises, prevents stiffening of conveyor belts, for direct contact with foodstuffs, H1 registered, 3H registered, halal and kosher certified, certified according to ISO 21469
<b>Berulfluid WO</b> 9362201 	Medical white oil	17	98	-	≥ 170	AN	Medical white oil, odorless and tasteless, water repellent, corrosion protection, resin-free and acid free, medically pure, eliminates squeaks, removes contamination, high creeping capacity, for lubricating the guide rails in dough dividers, H1 registered
<b>Berulub Fluid W+B</b> 9012201 	Medical white oil	70	-	-6	≥ 225	AN	Multifunction oil, odorless and taste, water repellent, corrosion protection, removes contamination and rust, resin and acid free, medically pure according to the valid Pharmacopoea Europaea and United States Pharmacopeia, ideal for chains in flour-dust environment, H1 registered, halal certificate
<b>Berusynth 15 H1</b> 9362219 	Polyalphaolefin (PAO)	15	125	-65	170	HLP HC	High-performance oil for circulation lubrication and for transport chains, hydraulic equipment, gear units, blowers, air compressors, effective corrosion and wear protection, neutral to conventional seals and paints, odorless and taste, H1-registered, halal and kosher certified, certified according to ISO 21469
<b>Berusynth 32 H1</b> 9362419 	Polyalphaolefin (PAO)	32	140	-65	≥ 220	CLP HC, HLP HC, VDL HC	High-performance oil for circulation lubrication and for transport chains, hydraulic equipment, gear units, blowers, air compressors, effective corrosion and wear protection, neutral to conventional seals and paints, odorless and taste, H1-registered, halal and kosher certified, certified according to ISO 21469

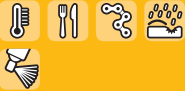
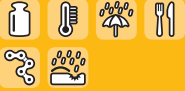
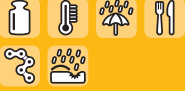

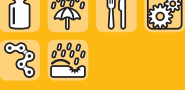
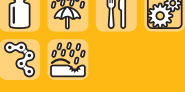
Product	Base oil	Kinematic viscosity at 40 °C [mm <sup>2</sup> /s]				Description according to DIN	Description
		Viscosity Index	Pourpoint [°C]	Flash point approx. [°C]			
<b>Beresynt 46 H1</b> 9362229 	Polyal-phaolefin (PAO)	46	140	-60	≥ 240	CLP HC, HLP HC, HVLP HC, VDL HC	High-performance oil for circulation lubrication and for transport chains, hydraulic equipment, gear units, blowers, air compressors, effective corrosion and wear protection, neutral to conventional seals and paints, odorless and taste, H1-registered, halal and kosher certified, certified according to ISO 21469
<b>Beresynt 68 H1</b> 9362239 	Polyal-phaolefin (PAO)	68	145	-55	≥ 240	CLP HC, HLP HC, HVLP HC, VDL HC	High-performance oil for circulation lubrication and for transport chains, hydraulic equipment, gear units, blowers, air compressors, effective corrosion and wear protection, neutral to conventional seals and paints, odorless and taste, H1-registered, halal and kosher certified, certified according to ISO 21469
<b>Beresynt 100 H1</b> 9362249 	Polyal-phaolefin (PAO)	100	145	-50	≥ 250	CLP HC, HLP HC, VDL HC	High-performance oil for circulation lubrication and for transport chains, hydraulic equipment, gear units, blowers, air compressors, effective corrosion and wear protection, neutral to conventional seals and paints, odorless and taste, H1-registered, halal and kosher certified, certified according to ISO 21469
<b>Beresynt 150 H1</b> 9362229 	Polyal-phaolefin (PAO)	150	145	-50	≥ 250	CLP HC, HLP HC, VDL HC	High-performance oil for circulation lubrication and for transport chains, hydraulic equipment, gear units, blowers, air compressors, effective corrosion and wear protection, neutral to conventional seals and paints, odorless and taste, H1-registered, halal and kosher certified, certified according to ISO 21469
<b>Beresynt 220 H1</b> 9362259 	Polyal-phaolefin (PAO)	220	150	-50	≥ 250	CLP HC	High-performance oil for circulation lubrication and for transport chains, hydraulic equipment, gear units, blowers, air compressors, effective corrosion and wear protection, neutral to conventional seals and paints, odorless and taste, H1-registered, halal and kosher certified, certified according to ISO 21469
<b>Beresynt 320 H1</b> 9362349 	Polyal-phaolefin (PAO)	320	150	-45	≥ 250	CLP HC	High-performance oil for circulation lubrication and for transport chains, hydraulic equipment, gear units, blowers, air compressors, effective corrosion and wear protection, neutral to conventional seals and paints, odorless and taste, H1-registered, halal and kosher certified, certified according to ISO 21469
<b>Beresynt 460 H1</b> 9362269 	Polyal-phaolefin (PAO)	460	150	-40	≥ 255	CLP HC	High-performance oil for circulation lubrication and for transport chains, hydraulic equipment, gear units, blowers, air compressors, effective corrosion and wear protection, neutral to conventional seals and paints, odorless and taste, H1-registered, halal and kosher certified, certified according to ISO 21469
<b>Beresynt 680 H1</b> 9362279 	Polyal-phaolefin (PAO)	680	155	-35	≥ 260	CLP HC	High-performance oil for circulation lubrication and for transport chains, hydraulic equipment, gear units, blowers, air compressors, effective corrosion and wear protection, neutral to conventional seals and paints, odorless and taste, H1-registered, halal and kosher certified, certified according to ISO 21469
<b>Beresynt 1000 H1</b> 9362289 	Polyal-phaolefin (PAO)	1000	165	-35	≥ 260	CLP HC	High-performance oil for circulation lubrication and for transport chains, hydraulic equipment, gear units, blowers, air compressors, effective corrosion and wear protection, neutral to conventional seals and paints, odorless and taste, H1-registered, halal and kosher certified, certified according to ISO 21469

All indications and values correspond to latest knowledge and do not represent any product specification.

Product	Base oil	Kinematic viscosity at 40 °C [mm²/s]					Description according to DIN	Description
		Viscosity index	Pourpoint [°C]	Flash point approx. [°C]				
<b>Berusynth 1000 H1 Spray</b> 5301429 	Polyal-phaolefin (PAO)	1000	-	-	-	-	Adhesive high-performance chain oil, high load-carrying capacity, excellent corrosion protection and wear as a result of the high viscosity, transparent, H1 registered	
<b>Berusynth CB 180 H1</b> 9303609 	Ester	180	145	-45	≥ 235	-	High-temperature chain oil, wide application temperature range, excellent wetting and creeping properties, resistant to hot and cold water, good corrosion protection, no critical formation of residues, H1 registered, halal and kosher certified, certified according to ISO 21469	
<b>Berusynth CG 370 H1</b> 9303109 	Polyglycol	-	230	-	≥ 200	-	Synthetic high-temperature chain oil, at +200 °C effective as fluid lubricant, at higher temperatures the synthetic carrier fluid evaporates without leaving any residues, the remaining dry lubricating film guarantees reliable lubrication at temperatures up to +650 °C, H1 registered	
<b>Berusynth H1 Spray</b> 5301419 	Polyal-phaolefin (PAO)	100	140	-	-	-	Transparent chain oil/adhesive oil, good corrosion and wear protection, high load-carrying capacity, solvent free, H1-registered	
<b>Berusynth PG 220 H1</b> 9590009 	Polyglycol	220	220	-36	≥ 200	CLP PG	High-performance oil for gear units, roller bearings and plain bearings as well as for transport chains and drive chains running under high mechanical and thermal load, high wear and corrosion protection, odorless and taste, H1 certified	
<b>Berusynth PG 460 H1</b> 9590129 	Polyglycol	460	230	-36	≥ 200	CLP PG	High-performance oil for gear units, roller and plain bearings as well as for transport and transmission chains running at high mechanical and thermal load, high wear and corrosion protection, odorless and taste, H1 registered	
<b>Berusynth PG 680 H1</b> 9590139 	Polyglycol	680	260	-36	≥ 200	CLP PG	High-performance oil for gear units, roller bearings and plain bearings as well as for transport chains and drive chains running under high mechanical and thermal load, high wear and corrosion protection, odorless and taste, H1 certified	
<b>Beruclean H1 Spray</b> 5301202 	Medical white oil	-	-	-	-	-	Degreaser and brake cleaner, removes all types of oil and grease contamination as well as not yet hardened paints and coatings, dissipates without residues, excellent corrosion protection, H1 registered	
<b>Berulub GD 50 H1 Spray</b> 5301812 	Medical white oil	-	-	-	-	-	Rust remover with additional lubricating and corrosion protection properties, high creeping capacity, not resinous, H1 registered	

Service products

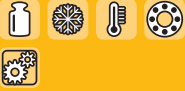

Product	Base oil	Kinematic viscosity at 40 °C [mm <sup>2</sup> /s]				Viscosity index	Pourpoint [°C]	Flash point approx. [°C]	Standards	Description according to DIN	
										Description	
<b>BECEM Staroil G 320</b> 9553501 	Mineral oil	320	95	-18	≥ 230	DIN 51517-3	CLP	High-performance gear oil for spur, bevel, planetary and worm gears, excellent wear protection, very high ageing resistance, good load-carrying capacity and viscosity/temperature behavior, excellent water and air separation capacity			
<b>Berusynth GP 150</b> 9351509 	Polyalphaolefin (PAO)	143	155	-45	≥ 265	DIN 51517-3	CLP HC	High-performance gear oil on polyalphaolefin basis for heavy-duty spur, bevel, planetary and worm gear units, enables extended oil changing intervals, excellent wear protection, very high ageing resistance, miscible with mineral oil			
<b>Berusynth CU 250</b> 9306509 	Ester	250	120	-45	≥ 250	-	-	High-temperature chain oil, wide application temperature range, excellent wetting and creeping properties, hot and cold water resistant, good corrosion protection, no formation of critical residues, H2-registered, adjusted to Berusynth CC 100			

Textile processing





All indications and values correspond to latest knowledge and do not represent any product specification.



# Pastes









BECHEM offers an extensive range of pastes for the applications in service, maintenance and assembly. Compared to lubricating greases pastes have a considerably higher ratio of solid lubricants and thickeners. Based on their excellent friction and wear values, pastes are mainly suitable for all applications where very high pressures and extremely high temperatures are involved. They actively prevent fretting corrosion. Pastes are suitable as antiseize agent for multiple assembly tasks, e.g. to avoid cold welding of inserted tools and wear bushings of pneumatic tools.



## CORE RANGE

Ask about our local custom solutions

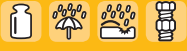

Product	Base oil	Thickener	NLGI-grade	Kinematic viscosity at 40 °C / 100 °C [mm <sup>2</sup> /s]		Description
				370 60	-30 1150	
<b>Berulub VPN 13</b> 9008509 	Polyglycol	Bentonite	1*	370 60	-30 1150	High-temperature and parting agent paste for all screw connections, application temperature up to +1150 °C, contains copper particles, reliable corrosion protection, decreases the breakaway torque 
<b>Berulub Nickel Paste</b> 5400909 	Polyglycol	Bentonite	1	370 60	-30 1450	Adhesive and parting agent paste for all screw connections, contains solid lubricants, suitable for high temperatures, protects against fretting corrosion, good sealing capacity, no abrasive residues
<b>Berulub FZ 2 S</b> 9011199 	Silicone oil	Bentonite	2-3*	75 32	-40 150	Light-colored heat sink paste, neutral towards plastics and metals, resistant to oxidation and ageing, non toxic, odorless, prevents air gaps 
<b>Berulub VPN 13 Ringlub</b> 9303009 	Synthetic oil	-	-	150 -	-30 1150	High-temperature fluid, e.g. for floating tires of rotary kilns, sprayable, excellent wear protection, very high ignition temperature, low smoke development on hot surfaces
<b>Berulub 151 Assembly Paste</b> 2902902 	White oil	Lithium soap	2-3*	17 4	-25 150	Light-colored multi-purpose paste with solid lubricants, resistant to water, excellent corrosion protection and fretting corrosion protection, good lubricating effect, prevents stick-slip
<b>Berulub FZ 1 E 3</b> 9011219 	Synthetic ester	Bentonite, Metal oxides	2-3*	90 13	-40 150	Light-colored heat sink paste, does not contain any silicones, optimally adjusts to the surface roughness of the semiconductors and cooling elements, prevents air gaps with poor heat transfer

All indications and values correspond to latest knowledge and do not represent any product specification.

# Berulub W+B Spray

Schmieröl / Lubricating oil

Multifunktionsöl für die Lebensmittelindustrie / Multifunctional oil for the food processing industry

400 ml

**BECHEM**  
LUBRICATION  
TECHNOLOGY

# Berulub GD 50 H1 Spray

Schmieröl / Lubricating oil

Rostlöser für die Lebensmittel- und Pharmaindustrie / Rust remover for the food processing and pharmaceutical industry

400 ml

**BECHEM**  
LUBRICATION  
TECHNOLOGY

# Beruprotect Spray

Coating

Korrosionsschutz / Corrosion protection

400 ml

**BECHEM**  
LUBRICATION  
TECHNOLOGY

# Berulub FR 4 Spray

Schmierfett / Lubricating grease

Gleit- und Dämpfungschmierstoff / Anti-friction and damping lubricant

400 ml

Zulassung nach / Approbation according to:  
VW-7L, 728 B, Ford WSD, Boreal Gruppe 53.2, Daikin

**BECHEM**  
LUBRICATION  
TECHNOLOGY

# Sprays

For easy handling and application BECHEM offers a range of lubricants, cleaners, corrosion inhibitors, degreasers and rust removers in spray cans.



**CORE RANGE**  
Ask about our local custom solutions











## Sprays







For demanding application fields in automotive engineering, the food industry and mechanical and plant engineering, or for the harsh conditions in the heavy industry, BECHEM offers the industrial user a high quality assortment of lubricating greases for a wide variety of tribological issues.

Product	Base oil	Thickener	Kinematic viscosity at 40 °C /100 °C [mm <sup>2</sup> /s]		Description
				Working temperature range [°C]	
<b>BECHEM Fluid W 68-3H Spray</b> 5301112 	Medical white oil	–	68 8,6	-10 120	Parting agent and lubricating agent for direct contact with foodstuffs, odorless and tasteless, good corrosion protection, free from animal ingredients, genetically modified ingredients and nut oils, 3H certified
<b>BECHEM High-Lub SW 2 Spray</b> 5305809 	Mineral oil	Special calcium soap	100 9	-25 80	Universal lubricant and long-term corrosion protection even at contact with saltwater, good water resistance, excellent wear protection thanks to EP-additives
<b>Beruclean H1 Spray</b> 5301202 	Medical white oil	–	– –	–	Degreaser and brake cleaner, removes all types of oil and grease contamination as well as not yet hardened paints and coatings, dissipates without residues, excellent corrosion protection, H1 registered
<b>Berucoat AF 438 Spray</b> 5302419 	–	–	– –	-180 450	Anti-friction coating spray for metal contact partners, prevents stick-slip, adheres on smooth surfaces, contains microfine solid lubricants, no adhesion of dirt particles
<b>Beruglide Spray</b> 5351209 	Perfluoropolyether (PFPE)	Polytetrafluoroethylene (PTFE)	160 16	-40 190	Excellent compatibility with plastics and elastomer materials, excellent oxidation resistance, good noise damping, good fogging properties, H1 registered
<b>Berulit GA 2500 Spray</b> 5308609 	Mineral oil, Synthetic oil	Aluminium complex soap	2500 100	-20 200	Operating lubricant optimally suited for sliding contacts steel/steel excellent wear protection, excellent adhesion, high load-carrying capacity, solid lubricant graphite
<b>Berulit Gear Spray</b> 5300509 	Mineral oil	–	– –	–	Sprayable lubricant, good wear and corrosion protection, outstanding adhesion, resistant to water and water repellent
<b>Berulub ECO GD 40 Spray</b> 5351202 	Ester	–	– –	-30 90	Multifunction spray, readily biodegradable acc. to OECD 301 C, acid and resin free, odorless, suitable as rust solvent, corrosion protection, cleaning and maintenance agent, water repellent, good creeping properties

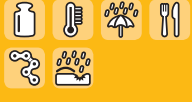

Product	Base oil	Thickener	Kinematic viscosity at 40 °C / 100 °C [mm <sup>2</sup> /s]		Description
			150	-40	
<b>Berulub FG-H 2 EP Spray</b> 5301439 	Polyalphaolefin (PAO)	Special calcium complex soap	150 18,5	-40 160	High-performance lubricant for cam discs, guides, plain rollers and small gear units, good adhesion and sealing effect, resistant to hot/cold water, high load-carrying capacity, good corrosion protection, H1 registered, Halal and Kosher certified
<b>Berulub FR 43 Spray</b> 5305202 	Polyalphaolefin (PAO)	Special lithium soap	32 6	-50 140	For the material pairs metal/plastic and plastic/metal, excellent low temperature behavior, water-resistant and oxidation resistant, contains PTFE, e.g. for the lubrication of lock mechanisms of package holders (textile industry)
<b>Berulub GD 50 H1 Spray</b> 5301812 	Medical white oil	–	– –	–	Rust remover with additional lubricating and corrosion protection properties, high creeping capacity, not resinous, H1 registered
<b>Berulub ND Spray</b> 5300219 	Perfluoropolyether (PFPE)	–	160 16	-40 200	Fully synthetic special spray for noise damping in automotive applications, good plastic and elastomer compatibility, odorless, high thermal and oxidation resistance
<b>Berulub Palfluid Spray</b> 5305609 	Ester	Polytetrafluoroethylene (PTFE)	2200 180	-20 150	Multi-purpose, low-temperature paste prevents stick-slip, extends relubrication intervals, excellent adhesion, media-resistant, contains PTFE, optimally suited for contact combinations of steel with PTFE/PA
<b>Berulub VPN 13 Spray</b> 5310309 	Polyglycol	Bentonite	370 60	-30 1150	High-temperature and parting agent spray for all screw connections, application temperature up to +1150 °C, contains copper particles, reliable corrosion protection, decreases the breakaway torque
<b>Berulub W+B Spray</b> 5301109 	Medical white oil	–	70 8,5	–	Colorless rust remover with additional lubricating and corrosion protection properties, high creeping capacity, not resinous, acid-free, medically clean lubricating oil, H1 registered
<b>Beruprotect Rope Spray</b> 5302319 	Mineral oil	–	– –	-20 100	Wire rope lubricant, fluid, good creeping properties, excellent wear and corrosion protection, outstanding adhesion, excellent wetting properties
<b>Beruprotect Spray</b> 5310809 	Mineral oil	–	– –	–	Solvent containing protective wax for long-term rust prevention, outstanding adhesive properties, also suitable for salt water atmosphere

All indications and values correspond to latest knowledge and do not represent any product specification.

Product	Base oil	Thickener	Kinematic viscosity at 40 °C / 100 °C [mm <sup>2</sup> /s]		Description
			260	-40	
<b>Berasil P 140 Spray</b> 5304409 	Silicone oil	–	260 110	-40 150	Suitable for non-ferrous metals, plastics and elastomers, extremely low evaporation losses in high temperature range, physiologically harmless, neutral in odor and taste, H1 registered
<b>Berusynth 1000 H1 Spray</b> 5301429 	Polyalphaolefin (PAO)	–	1000 83	-30 200	Adhesive high-performance chain oil, high load-carrying capacity, excellent corrosion protection and wear as a result of the high viscosity, transparent, H1 registered
<b>Berusynth CB 180 H1 Spray</b> 5312209 	Ester	–	– –	-40 230	Synthetic high-temperature chain oil, extended application temperature range, excellent wetting and creeping capability, hot and cold water resistant, good corrosion protection, no critical residue formation
<b>Berusynth CP 80 Spray</b> 5301309 	Mineral oil	–	– –	-15 150	Chain spray with excellent adhesion, good creeping and dry running properties, good wetting properties, good corrosion and wear protection, high wash-out stability, long lubrication intervals
<b>Berusynth CU 250 Spray</b> 5342419 	Ester	–	250 24	250	Synthetic high-performance chain oil, excellent penetration properties, good corrosion protection, high wash-out stability, low evaporation rate, no tendency to form critical residues, H2 registered
<b>Berusynth CU 3000 Spray</b> 5342429 	Ester	–	3000 180	-15 250	Synthetic high-performance chain oil, long-term lubrication, excellent wear protection, extremely adhesive, high wash-out stability, good corrosion protection, prevents stick-slip
<b>Berusynth H1 Spray</b> 5301419 	Polyalphaolefin (PAO)	–	100 15	-50 200	Transparent chain oil/adhesive oil, good corrosion and wear protection, high load-carrying capacity, solvent free, H1-registered



All indications and values correspond to latest knowledge and do not represent any product specification.

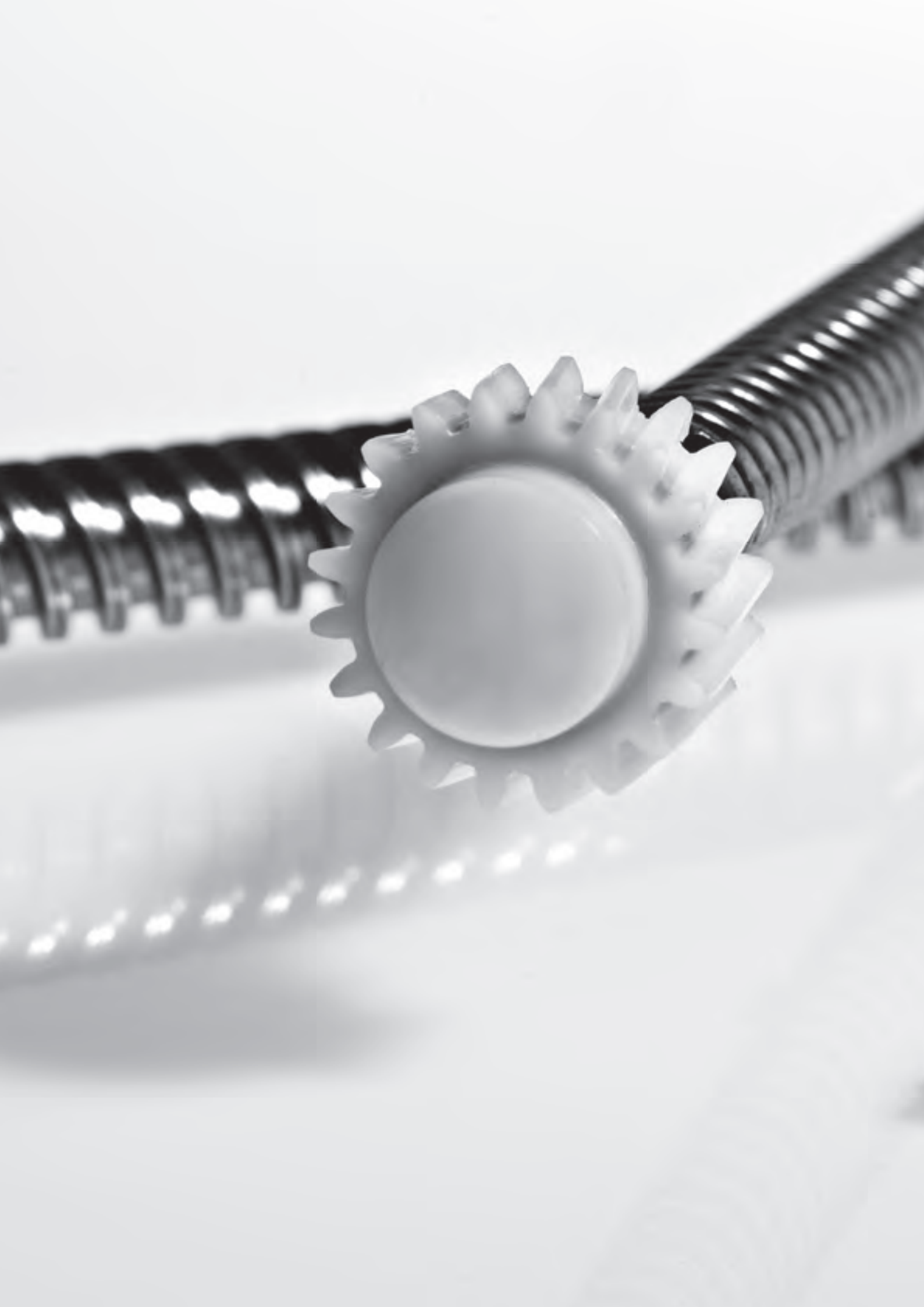

# Anti-friction coatings

Anti-Friction Coatings are dry lubricant solutions, where their formulation, resemble common industrial paints. Anti-Friction Coatings contain solid lubricants, a resin/binders system and a carrier system such as a solvent or water. Solid lubricant components are mainly molybdenum disulphide, graphite and PTFE. The individual raw materials and additives, as well as the concentration of solid lubricants are decisive for lubricating efficiency and corrosion protection. Anti-Friction Coatings are used to reduce friction, reduce wear, provide a corrosion barrier, and aesthetics.

Anti-Friction Coatings are preferably applied by immersion or by spraying onto carefully degreased surfaces. Other methods are possible as well, such as dip/spin, electrostatic or automatic spraying methods, application by pressure or roller as well as the various methods for drying and hardening processes which are well-known within industry.

## CORE RANGE



Ask about our local custom solutions



## Anti-Friction Coatings

The special product series of anti-friction coatings, Berucoat AF, AK and FX, offer both numerous advantages and individual application possibilities in all industrial fields, especially for bulk commodities, regardless of whether metal, plastic, elastomer or leather materials are involved.

Product	Composition	Solvent	Working temperature range [°C]		Curing	Description
			Dry layer optics			
<b>Berucoat AF 130</b> 9100109 	Organic binder, Organic solvent, Solid lubricants	Alcohol, Ester, Ketone	-70 250	black	heat curing	Long-term lubrication of metal/metal material combinations, pressure resistant, excellent adhesion, prevents stick-slip, outstanding corrosion protection, oil resistant, burn-in temperature +120 °C
<b>Berucoat AF 291</b> 9100169 	Graphite, Organic binder, Organic solvent	Ketone	-40 250	black	heat curing	Suitable for metal/metal material combinations, excellent adhesion, good corrosion protection, resistant to oil, grease and solvents, high abrasion resistance
<b>Berucoat AF 320 E</b> 9100189 	Organic binder, Organic solvents, PTFE	Ester, Glycol ethers	-70 250	-	heat curing	Suitable for plastic/steel combinations, long-term coating, prevents stick-slip, no dust adsorption, excellent corrosion protection, oil resistant, burn-in temperature +120 °C
<b>Berucoat AF 438</b> 9100009 	Graphite, Inorganic binder, MoS <sub>2</sub> , Organic solvents	Ester, Fuel	-180 450	-	air curing	Suitable for metal/metal material combinations, prevents stick-slip, good adhesion on smooth surfaces, no dust adhesion, good resistance against radiation, lowest evaporation in high vacuum
<b>Berucoat AF 481</b> 9100179 	Graphite, MoS <sub>2</sub> , Organic binder, Organic solvent	Aromatic hydrocarbon, Ketone	-40 250	grey	heat curing	Suitable for metal/metal material combinations, oil, grease and solvent resistant, high pressure and excellent temperature resistance
<b>Berucoat AF 732</b> 9100019 	MoS <sub>2</sub> , Organic binder, Organic solvents, PTFE	Alcohol, Ester	-70 250	-	heat curing	Suitable for metal/metal material combinations, long-term coating, excellent adhesion, no sticking of dust, prevents stick-slip, excellent corrosion protection, oil resistant
<b>Berucoat AK 376</b> 9100069 	Organic binder, PTFE	Water	-40 120	-	air curing	Long-term lubrication for plastic and/or steel material combinations, no dust adhesion, prevents stick-slip, good corrosion protection
<b>Berucoat AK 978</b> 9100039 	Combination of solid lubricants, Organic binder	Water	-40 80	-	air curing	Water based interior AF-coating, prevents stick-slip and disturbing noises, highly compatible with plastics, transparent, free of formaldehyde

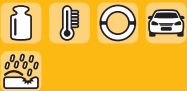
Product	Composition	Solvent	Working temperature range [°C]	Dry layer optics		Description
					Curing	
<b>Berucoat FX 270</b> 9100099 	Graphite, Organic binder	Water	-40 300	–	air curing	Elastomer coating, prevents stick-slip, resistant to cleaning agents, wear resistant, temperature resistant, no organic solvents, parting effect even in the high temperature range
<b>Berucoat FX 670</b> 9100089 	Graphite, Organic binder, PTFE	Water	-40 250	–	air curing	Elastomer coating, prevents stick-slip, resistant to cleaning agents, wear resistant, temperature resistant
<b>Berucoat FX 876</b> 9100159 	Combination of solid lubricants, Organic binder	Water	-40 80	–	air curing	Long-term elastomer coating, water based, two-component coating, noise damping, reduction of friction, good water resistance, wear resistant
<b>Berulub AF 230</b> 9100329 	Organic binder, Organic solvent, Solid lubricants	–	-70 250	grey	heat curing	Suitable for metal/metal material combinations, high pressure and excellent temperature resistance, resistant to oil, grease and solvents, excellent adhesion, good corrosion protection

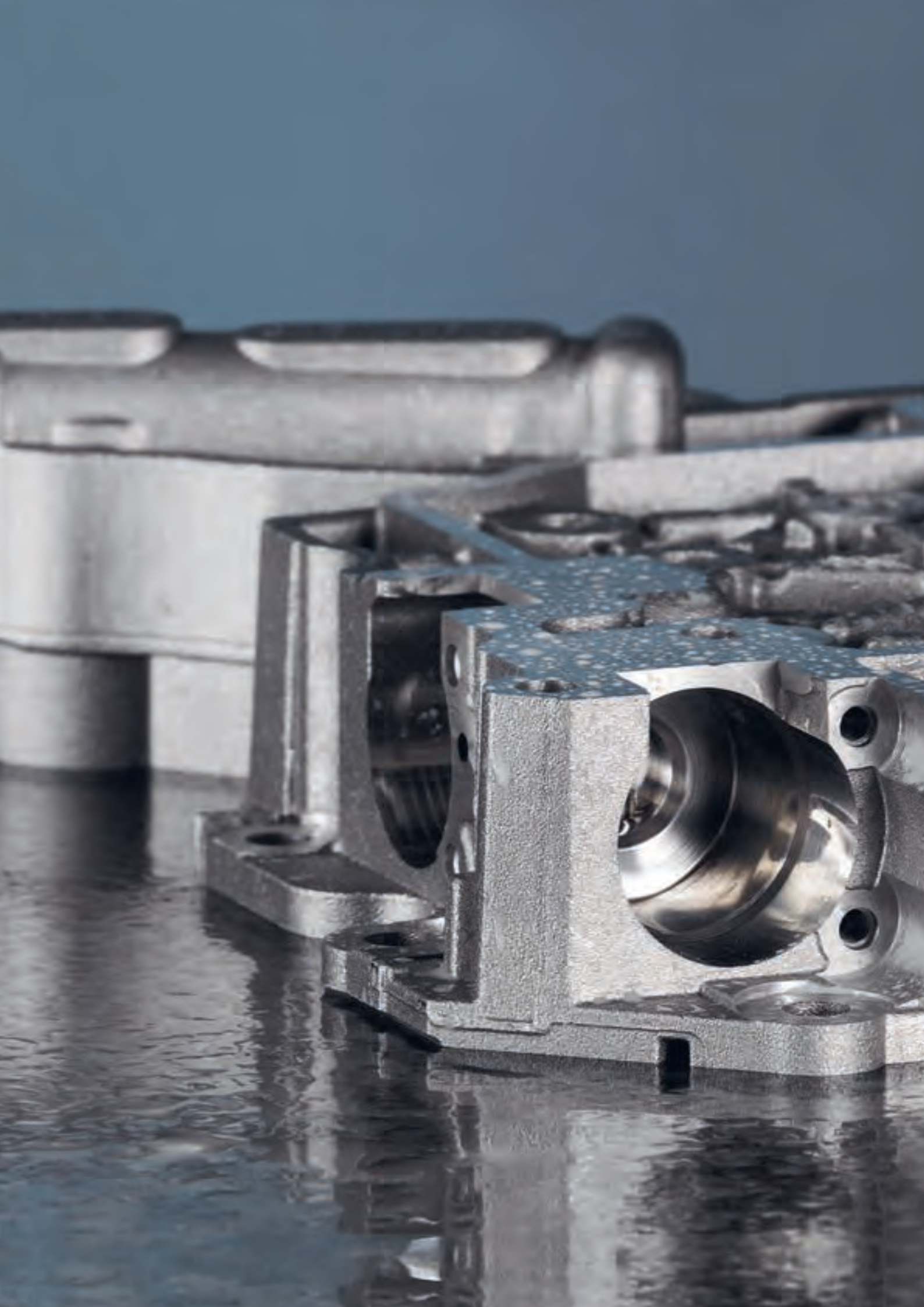



# Coolants for metal removal operations

Modern machining operations with defined and undefined cutting edges are characterised by machine tools with high feed rates and cutting speeds. For construction reasons demanding materials are used in increasing quantities.

As a developer and manufacturer of coolants, BECHEM has offered highperformance cooling to this demanding market segment for decades. The BECHEM Avantin, Berucol and Berucut product series covers the whole range of water miscible and non water miscible coolants. The modern structure of these products ensures maximum efficiency for all operating conditions. In these conventional coolants either the cooling or the lubricating properties dominate, depending on their structure. Water and oil can be considered as the common base fluids.

With the Berufluid coolant concept BECHEM is the pioneer of a new generation of lubricants: viscous water with its oily lubricating and excellent cooling properties forms the basis for a family of extremely high-performance products which are totally free of mineral oil.

- **Water miscible coolants**
- **Non water miscible coolants**

## CORE RANGE

Ask about our local custom solutions





## Water miscible coolants





The products of the proven water miscible and water soluble BECHEM Avantin and Berucool product series are all tailored to particular requirements as a result of their special composition. The modern system structure of our water miscible and water soluble coolants is reflected in all operating conditions and delivers optimal performance.





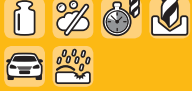



Product	Materials to be processed	Mineral oil approx. [%]	Amin-free	Performance additives	Applications	Description
<b>BECHEM Avantin 251</b> 9611352 	Aluminum, Cast iron, Non-ferrous metals, Steel	45	-	-	General to demanding cutting operations and grinding	Universal use at high and low water hardness
<b>BECHEM Avantin 255 FF</b> 9612642 	Aluminum, Nickel-base material, Steel, Titanium	42	•	•	Turning, drilling, milling, deep drilling, automotive, forming, CBN and PKD grinding	Universal, high-performance formulation for high and low water hardness
<b>BECHEM Avantin 270</b> 9611612 	Aluminum, Cast iron, Non-ferrous metals, Steel	67	-	•	All-round processing in multi-metal-mix	Universal use at high and low water hardness, improved temporary corrosion protection
<b>BECHEM Avantin 361 FF</b> 9605382 	Aluminium alloys, Cast iron, Non-ferrous metals, Steel	46	•	•	Turning, drilling, milling, grinding, sawing, motor manufacturing, die-cast processing, chassis components	Semi-synthetic formulation with excellent flushing properties and surface quality, optimized for soft and hard water, good skin tolerance
<b>BECHEM Avantin 405</b> 9910399 	Cast iron, Steel	-	•	-	General metal cutting and grinding, thread milling	Fully synthetic high-performance formulation, excellent temporary corrosion protection
<b>BECHEM Avantin 420</b> 9612592 	Cast iron, Steel	20	•	•	Turning, drilling, milling, grinding	Semi-synthetic formulation with excellent dirt-bearing capacity, excellent corrosion protection, good foam control, good cleaning effect
<b>BECHEM Avantin 438</b> 9600222 	High alloyed steels, Nickel-based alloys	28	•	•	Deep drilling, broaching, cylinder tube processing, demanding forming operations	Semi-synthetic high-performance formulation for excellent surface qualities and maximum tool life
<b>BECHEM Avantin 451</b> 9611802 	Aluminum, Cast iron, Non-ferrous metals, Steel, Titanium	45	•	-	General to demanding cutting operations, machining of engine blocks and cylinder heads, transmissions, pistons	Universal high-performance formulation for excellent surface qualities

Boron and formaldehyde-free

Product	Materials to be processed	Mineral oil approx. [%]	Amin-free		Performance additives	Applications	Description
<b>BECEM Avantin 455</b> 9600192 	Aluminum, Non-ferrous metals, Steel, Titanium	35	•	•	General to demanding metal cutting operations, machining of engine blocks, cylinder heads, transmission housings, pistons	Excellent surface qualities especially of aluminum alloys used in the automotive and aerospace industry	
<b>BECEM Avantin 4015</b> 9910699 	Aluminum, Steel	–	•	•	General to demanding metal cutting operations and grinding, thread milling	Fully synthetic formulation for universal, high-performance implementation, excellent flushing properties	
<b>BECEM Avantin 4409</b> 9612539 	ADI-materials, High-tensile stainless steels, Nickel-based alloys	–	•	•	Deep drilling, broaching, cylinder tube processing, demanding forming operations	Fully synthetic high-performance formulation, highest tool life, excellent surface qualities, can also be used as additive and for forming processes	
<b>Berucol HM</b> 9612349 	Carbide	–	•	–	Grinding, engraving	Excellent surface qualities, with cobalt inhibitor	
<b>Berufluid AL 1004</b> 9940159 	Aluminum, Steel, Titanium	–	•	–	Turning, drilling and milling, produces excellent surfaces	High performance, extended tool life, excellent corrosion protection, prevents spotting, excellent cooling properties, low foaming, skin-friendly	
<b>Berufluid AS 1006</b> 9940229 	Aluminum, Cast iron, Steel	–	•	•	General metal cutting and grinding operations	Synthetic, high-performance formulation, excellent flushing properties, excellent temporary corrosion protection, low adhesion tendency, good biostability, excellent foaming behavior	
<b>Berufluid AS 1008</b> 9940349 	Aluminum, Steel, Titanium	–	•	•	Drilling turning, milling, optical components, control and regulation technology	High performance, optimal tool life, excellent cooling properties, excellent filterability, reduced aerosol formation, for individually and centrally supplied systems	
<b>Berufluid Cut K</b> 9910629 	Cast iron, Molybdenum, Nickel-base material, Steel, Titanium	–	•	•	General metal cutting operations and grinding	High biostability, extended tool life, good corrosion protection, minimal drag, excellent foam behavior	
<b>Berufluid Cut 'n Grind 5</b> 9910679 	Cast iron, Nickel-base material, Stainless steel, Titanium	–	•	–	General metal cutting operations and grinding	Good biostability, extended tool life, good corrosion protection	





All indications and values correspond to latest knowledge and do not represent any product specification.

Product	Materials to be processed	Mineral oil approx. [%]			Performance additives	Applications	Description
			Amin-free				
<b>Berfluid Cut 'n Grind KA</b> 9940079 	Cast iron, Nickel-based alloys, Steel, Titanium	-	•	-	General metal cutting operations and grinding	Excellent filterability, low foaming, odorless	
<b>Berfluid Grind HM-B</b> 9910269 	Carbide, Cast iron, Steel, Titanium	-	•	-	Grinding in tool production, processing of cam shafts and piston rods (disc grinding), forming of non-ferrous metal	Excellent material removal flow rate with reduced tool wear, good biostability, good corrosion protection	
<b>Berfluid NE 1003</b> 9940179 	Low alloyed steels, Non-ferrous metals	-	-	-	General metal cutting and grinding operations	Inhibited against discoloration of non-ferrous metals, excellent filterability, good corrosion protection	
<b>Berfluid ST 1003</b> 9940029 	Cast iron alloys, Nickel-based alloys, Steel, Titanium alloys	-	•	-	General metal cutting operations and grinding	High performance, high biostability, excellent cooling properties, extended tool life, low material drags, compatible with aqueous cleaners	
<b>Berfluid ST 2003</b> 9940289 	Cast iron, Nickel-based alloys, Steel, Titanium	-	•	•	General metal cutting operations, grinding	High performance, excellent cooling properties, extended tool life, excellent corrosion protection, excellent filterability, low foaming	
 Boron-free	<b>BECEM Avantin 255</b> 9611562 	Aluminum, Nickel-base material, Steel, Titanium	42	-	-	Highest metal cutting performance, powertrain	Universal, high-performance formulation for high and low water hardness
	<b>BECEM Avantin 261</b> 9611422 	Aluminum, Cast iron, Non-ferrous metals, Steel	50	-	-	All-round processing in multi-metal-mix	Universal use at high and low water hardness, improved temporary corrosion protection
	<b>BECEM Avantin 400</b> 9910339 	Cast iron, Steel	-	•	•	Grinding	Fully synthetic formulation with excellent temporary corrosion protection
	<b>BECEM Avantin 402</b> 9401329 	Cast iron, Steel	-	•	-	General metal cutting and grinding operations, bright steel fabrication	Fully synthetic formulation with excellent temporary corrosion protection

Product	Materials to be processed			Mineral oil approx. [%]		Performance additives	Applications	Description
				Amin-free				
<b>BECEM Avantin 407</b> 9910459 	Cast iron, Steel	-	•	-	-	General metal cutting and grinding, thread milling	Fully synthetic high-performance formulation, excellent temporary corrosion protection	
<b>BECEM Avantin 408 M</b> 9910199 	Cast iron, Steel	-	•	-	-	Demanding metal cutting operations, e.g. cylinder tube processing	Fully synthetic high-performance formulation, excellent temporary corrosion protection	
<b>BECEM Avantin 426</b> 9612322 	Aluminum, Non-ferrous metals, Steel	20	•	-	-	General metal cutting and grinding operations	Especially suitable for highly sensitive aluminum alloys, optimal protection against discoloration	
<b>BECEM Avantin 320 FF</b> 9600292 	Low alloyed steels	15	•	•	•	Grinding of cylinder heads, crankshafts, camshafts, processing of gear casings, machining of engine blocks, production of clutch components	Semi-synthetic formulation, excellent flushing capacity, very low consumption	
<b>BECEM Avantin 331</b> 9611222 	Aluminum, Cast iron, Steel	30	•	-	-	General metal cutting and grinding processes	Semi-synthetic formulation for universal use, very good flushing performance	
<b>BECEM Avantin 331 FF</b> 9600302 	Aluminium alloys, Cast iron, Low alloyed steels	30	•	•	•	General metal cutting and grinding operations, machine construction and toolmaking	Semi-synthetic formulation for universal use, very good flushing performance	
<b>BECEM Avantin 340 FF</b> 9611072 	Aluminum, Cast iron, Low alloyed steels	33	•	•	•	General metal cutting and grinding operations, machine construction and toolmaking	Semi-synthetic formulation with good corrosion resistance, foaming behavior and flushing capacity, good filtration properties	
<b>BECEM Avantin 361 I-N</b> 9612022 	Aluminum, Cast iron, Non-ferrous metals, Steel	50	•	-	-	General to demanding cutting operations, machining of motor blocks and cylinder heads	Universal formulation for excellent surface qualities, optimal flushing effect	

Formaldehyde-free

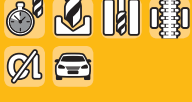
Contains boron and FAD

Product	Materials to be processed	Mineral oil approx. [%]	Amin-free	Performance additives	Applications	Description
<b>BECEM Avantin 310</b> 9612602 	Cast iron, Low alloyed steels	15	•	•	Grinding of cylinder heads, crankshafts, camshafts, processing of gear casings, machining of engine blocks, production of clutch components	Semi-synthetic formulation with excellent dirt-bearing capacity, excellent corrosion resistance, high filtration properties, high emulsion stability, good foam control
<b>BECEM Avantin 338</b> 9611272 	High alloyed steels, Nickel-base material	38	•	–	Deep drilling, broaching, cylinder tube processing, demanding forming operations	Semi-synthetic high-performance formulation for excellent surface qualities and maximum tool life
<b>BECEM Avantin 341</b> 9611792 	Aluminum, Cast iron, Medium and high alloy steel	30	•	–	General to demanding metal cutting operations and grinding	Semi-synthetic formulation with excellent flushing properties and optimized performance concept
<b>BECEM Avantin 3309</b> 9612229 	ADI-materials, High-tensile stainless steels, Nickel-base material	–	•	–	Deep drilling, broaching, cylinder tube processing, demanding forming operations	Fully synthetic high-performance formulation, longest tool life, excellent surface qualities, can also be used as additive and for forming processes
<b>BECEM Avantin 3332</b> 9612252 	Aluminum, Cast iron steel, Steel, Titanium	30	•	–	General to demanding metal cutting operations and grinding	Semi-synthetic formulation with excellent flushing properties and optimized performance concept



### Non water miscible coolants

BECHEM's series of non water miscible products Berucut and Beruform is suitable for easy and demanding machining operations such as turning, drilling, milling, thread cutting, grinding, broaching and sawing. The cutting and grinding oils are tailored to the large variety of materials to be processed.

Product	Materials to be processed		Kinematic viscosity at 40 °C [mm <sup>2</sup> /s]	Flash point approx. [°C]	Performance additives	Applications	Description
<b>Berucut 10</b> 9960452 	Aluminum, Cast iron, Non-ferrous metals	9	≥ 150	•	Honing, grinding, finishing	Ensures high surface qualities, formation of built-up edges is efficiently prevented, also suitable as multi-purpose oil for hydraulic, gear and circulation lubrication	
<b>Berucut 15</b> 9912232 	Cast iron, Steel	15	≥ 150	–	Easy to medium-difficulty metal cutting operations, grinding, deep drilling, gear manufacturing	High load-carrying and flushing capacity, high flash point, powerful AW/EP additives	
<b>Berucut 22</b> 9960482 	Aluminium alloys, Copper alloys, Steel alloys	22	≥ 200	•	Turning, drilling, milling, grinding	Ensures high surface qualities, formation of built-up edges is efficiently prevented, also suitable as multi-purpose oil for hydraulic, gear and circulation lubrication	
<b>Berucut 32</b> 9960522 	Aluminum, Cast iron, Copper, Steel	32	≥ 216	•	Turning, drilling, milling	Ensures high surface qualities, formation of built-up edges is efficiently prevented, also suitable as multi-purpose oil for hydraulic, gear and circulation lubrication	
<b>Berucut RMO 822-8</b> 9762452 	Stainless steel, Steel	–	≥ 160	•	Vertical broaching, sawing, thread milling, cold massive forming	High-performance AW/EP-additives for high load-carrying capacity and high cutting performance, good flushing capacity	
<b>Berucut SCO 310</b> 9805702 	Steel	12	163	–	Turning, drilling, milling, grinding, deep drilling, thread milling, tooth flank grinding	High load-carrying and flushing capacity, high cutting speeds with extended tool life	
<b>Berucut SCO 322</b> 0302801 	Stainless steel, Steel	20,6	≥ 190	–	Turning, drilling, milling, thread cutting, tooth grinding and deep drilling	Lowest oil mist formation, formation of built-up edges is efficiently prevented	
<b>Berucut SCO 322 HC</b> 9761382 	Non-ferrous metals, Stainless steel, Steel, Titanium	22,1	168	–	Turning, drilling, milling, grinding, deep drilling, thread milling, tooth flank grinding	Lowest oil mist formation, formation of built-up edges is effectively prevented	

↓ Cutting and grinding oils

All indications and values correspond to latest knowledge and do not represent any product specification.

Product	Materials to be processed	Kinematic viscosity at 40 °C [mm²/s]			Performance additives	Applications	Description
				Flash point approx. [°C]			
<b>Berucut SFO 7 HC</b> 9805802 	Carbide, Cast iron steel, Stainless steel, Steel, Titanium	8	159	–	Honing, grinding, engraving	Low evaporation tendency, high sludge carrying properties	
<b>Berucut SFO 205</b> 9761452 	Non-ferrous metals, Steel	5,5	127	–	Honing, grinding, finishing	Achieves excellent surface qualities, extended tool life	
<b>Berucut XC 1010</b> 9765032 	Stainless steel, Steel	12,5	179	•	Turning, drilling, milling, grinding, deep drilling, thread milling, tooth flank grinding	High-performance AW/EP additives ensure a high load-carrying capacity and reduce wear and tear on the tool, support high cutting speeds, excellent flushing capacity	
<b>Berucut XC 1015</b> 9765112 	Non-ferrous metals, Stainless steel, Steel, Titanium, Chrome and cobalt alloys	15,5	182	•	Turning, drilling, milling, grinding, deep drilling, thread milling, tooth flank grinding	High-performance AW/EP additives ensure a high load-carrying capacity while reducing wear and tear on the tool, they support high cutting speeds with excellent flushing capacity	
<b>Berucut XC 1022</b> 9765042 	Cast iron, Steel	–	169	•	Turning, drilling, milling, grinding, deep drilling, tooth flank grinding	High-performance AW/EP additives ensure a high load-carrying capacity while reducing wear and tear on the tool, supporting high cutting speeds with excellent flushing capacity, extremely temperature-stable	
<b>Berucut XC 1110</b> 9765012 	Cast iron steel, Steel	10,5	178	•	Grinding, simple metal cutting	Excellent surface qualities, excellent dispersing properties with excellent residue behavior	
<b>Berucut XC 1115</b> 9765122 	Non-ferrous metals, Stainless steel, Steel, Titanium	15,5	187	•	Turning, drilling, milling, grinding, deep drilling, thread milling, tooth flank grinding	High-performance AW/EP-additives guarantee high load-carrying performance and reduced tool wear, low evaporation tendency, excellent flushing capacity	
<b>Berucut XC 1122</b> 9765052 	Non-ferrous metals, Stainless steel, Steel, Titanium	22,5	170	•	Turning, drilling, milling, grinding, deep drilling, thread milling, tooth flank grinding	High-performance AW/EP additives ensure a high load-carrying capacity while reducing wear and tear on the tool, supporting maximum cutting speeds at high-speed cutting with excellent flushing capacity, very temperature-stable	
<b>Berucut XC 2005</b> 9805112 	Carbide, Cast iron steel, Stainless steel, Steel, Titanium	5	145	•	Grinding, honing, engraving, tool manufacturing, mould construction, die manufacturing	Excellent surface qualities, excellent dispersing properties with excellent residue behavior	





Product	Materials to be processed	Kinematic viscosity at 40 °C [mm²/s]		Flash point approx. [°C]	Performance additives	Applications	Description
<b>Berucut XC 2007</b> 9805122 	Carbide, Cast iron steel, Stainless steel, Steel, Titanium	8	167	•	Honing, grinding, engraving	Excellent surface qualities with very low evaporation tendency, excellent dispersing properties with excellent residue behavior	
<b>Berucut XC 2105</b> 9765022 	Cast iron, Non-ferrous metals, Steel	5	139	•	Honing, grinding, finishing	Ensures high surface qualities	
<b>Berucut XC 4015</b> 9765062 	Steel	15	187	•	Deep drilling (all methods), peeling, rolling, burnishing	High-performance additive package for excellent surfaces, high performance in the cut, prevents build-up edges, strong cooling effect, supports demanding processing parameters, presence of cross-bores is not a problem	
<b>Berucut XC 4122</b> 9765082 	Aluminum, Copper based materials, Nickel-base material, Stainless steel, Steel	23	192	•	Deep drilling, peeling, rolling, burnishing, broaching, thread milling	High-performance additive package for excellent surfaces, high performance in the cut, suitable for steels, aluminum and nickel base alloys with tensile strengths of up to 800 N/mm²	
<b>Berucut XC 5022</b> 9765102 	Stainless steel, Steel	22,5	180	•	Vertical broaching, sawing, thread milling, cold massive forming	High-performance AW/EP additives for a high load-carrying capacity and strong cutting performance, excellent flushing capacity	
<b>Beruform 5032 D</b> 9762862 	Aluminum, Brass, Copper, Steel	32	≥ 200	•	Turning, drilling, milling	Multifunction oil suitable for metalworking processes and as hydraulic and machine oil, synergistic effects in case of leakages, excellent seal compatibility, good foam control	
<b>Berucut RMO 35 ZF</b> 9761912 	Stainless steel, Steel	35	≥ 150	–	Twist broaching (gears), internal broaching, external broaching, sawing, thread milling	Low evaporation tendency, high load-carrying and flushing capacity, high-performance AW/EP additives	
<b>Berucut RMO 244</b> 9762052 	Stainless steel, Steel	22,5	176	–	Vertical broaching, sawing, thread milling, cold massive forming	Low evaporation tendency, high load-carrying and flushing capacity, high-performance AW/EP additives	
<b>Berucut RMO TC 18 Package</b> 9762659 	Stainless steel, Steel	18,3	≥ 160	–	Vertical broaching (ball tracks)	Low-viscous additive package as a booster and as an additive for metalworking oils, in combination with broaching oils as an alternative to products containing chlorine	

↓ Broaching oils

All indications and values correspond to latest knowledge and do not represent any product specification.

	Product	Materials to be processed	Kinematic viscosity at 40 °C [mm²/s]			Flash point approx. [°C]	Performance additives	Applications	Description
			16	≥ 150	–				
Deep drilling oils	<b>Berucut TBO 315</b> 9660302 	Stainless steel, Steel	16	≥ 150	–	Deep drilling (all methods), peeling, rolling, burnishing	Suitable for steels with a tensile strength of up to 800 N/mm², where cross-bores are no problem		
	<b>Berucut TBO 315 ZF</b> 9762722 	Steel	15	154	•	Deep drilling (all methods), peeling, rolling, burnishing	Highest cutting performance and powerful additive package for excellent surfaces, avoids formation of built-up edges, excellent cooling properties, supports demanding machining processes where cross-bores are no problem		
	<b>Berucut TBO 422</b> 9762132 	Aluminum, Copper based materials, Nickel-base material, Stainless steel, Steel	23	179	–	Deep drilling, peeling, rolling, burnishing, broaching, thread milling	Suitable for steel, aluminum and nickel alloys with a tensile strength of up to 800 N/mm²		
	<b>Berucut TBO 622</b> 9761312 	Stainless steel	22,2	≥ 155	–	Deep drilling (all methods), broaching, and thread milling	Steel as well as nickel alloys with a tensile strength of up to 1300 N/mm²		
Minimum quantity lubricants	<b>Berucut 20 ZF</b> 9912449 	Aluminum, Low and high alloyed steels, Non-ferrous metals, Stainless steel	35	≥ 140	•	Turning, drilling, milling, sawing, punching, bending, rolling, pressing, thread milling	Non water miscible coolant, readily biodegradable		
	<b>Berucut MQL-A 16</b> 5204009 	Aluminum, Copper alloys, Steel	–	≥ 150	•	Non-cutting forming processes	Application possible at very low dosages, outstanding flushing capacity		
	<b>Berucut MQL-A 20</b> 5204309 	Aluminum, Non-ferrous metals, Stainless steel	26,8	≥ 170	•	Easy to medium metal cutting operations	Synthetic machining oil, especially suitable stain-free machining of sensitive aluminum alloys		
	<b>Berucut MQL-AP 20</b> 9762899 	Aluminium alloys, Low alloyed steels, Non-ferrous metals, Stainless steel	26,5	≥ 180	•	Turning, drilling, milling, sawing, punching, bending, rolling, pressing, thread milling	Synthetic coolant, contains PAO, minimal evaporation tendency		
	<b>Berucut MQL-E 30</b> 2309109 	Aluminum, Copper alloys, Steel	30	≥ 200	•	Medium to demanding metal cutting operations	Mineral oil free cutting oil, excellent flushing capacity		

Product	Materials to be processed	Kinematic viscosity at 40 °C [mm <sup>2</sup> /s]	Flash point approx. [°C]	Performance additives Applications	Description
<b>Berucut MQL-E 32</b> 9452309 	Aluminium alloys, Non-ferrous metals, Stainless steel, Steel alloys	35,9	≥ 230	<ul style="list-style-type: none"> <li>Turning, milling, drilling, reaming, thread cutting, sawing, punching, bending, rolling</li> </ul>	Mineral oil free cutting oil, excellent flushing capacity
<b>Berucut SCO 35 PC</b> 3700609 	Aluminum, Non-ferrous metals, Stainless steel, Steel	35	≥ 200	<ul style="list-style-type: none"> <li>Turning, milling, drilling, reaming, thread cutting, sawing, punching, bending, rolling</li> </ul>	Mineral oil free cutting oil, compatible with polycarbonates
<b>Berucut SCO 446 ECO</b> 9904799 	Aluminum, Non-ferrous metals, Stainless steel, Steel	41	≥ 200	– Turning, milling, deep drilling, sawing, rolling, thread milling, tooth flank grinding	Mineral oil free high-performance cutting oil based on readily biodegradable base oils



# Process media for forming technology

The BECHEM forming lubricants are used all over the world. When the shape of materials is to be changed in cold or hot processes, the liquid, solid, oily, soapy or aqueous BECHEM products help to minimise friction as well as the extreme surface pressure between tool or die and metal, even in case of extreme forming degrees.

BECHEM plays a key role in the manufacturing of semifinished and finished products of high precision and optimal surface quality, ready for their intended application or for finishing purposes in subsequent processes.

- **Sheet forming**
- **Wire drawing**
- **Cold forming oils**
- **Massive forming**
- **Tube drawing**

## CORE RANGE

Ask about our local custom solutions











## Sheet forming

Thanks to innovative product technologies and tailor-made lubrication solutions the BECHEM product range for sheet forming offers a high level of process reliability and efficiency. Extended tool life and excellent dimensional accuracy as well as outstanding surface qualities and low residues are a norm. In their development work, BECHEM mainly focuses on environmentally friendly, chlorine-free high-performance qualities.

	Product			Polar additives	EP-additives	Description	
	Kinematic viscosity at 40 °C [mm <sup>2</sup> /s]	Flash point approx. [°C]	Materials to be processed				
Volatilizing punching oils	<b>Beruform VSM 9</b> 9762922 	-	≥ 65	Aluminum, Copper, Copper alloys, Steel	-	-	Clean processing, virtually odorless, readily biodegradable according to OECD 301 F, H1 registered, Halal and Kosher certified
	<b>Beruform VSM 41</b> 9962522 	-	≥ 62	Aluminum, Brass, Copper, Steel	•	-	Low-residue processing, virtually odorless, chlorine-free, sulphur-free and heavy metal free
	<b>Beruform VSM 101</b> 9962472 	1,6	≥ 62	Aluminum, Brass, Copper, Steel	••	-	Non water-miscible, volatilizing forming oil, for nearly residue-free surfaces dry to the touch, nearly odor-free, free of chlorine, sulfur and heavy metals
	<b>Beruform VSM 164</b> 9762752 	-	≥ 62	Aluminum, Brass, Copper, Stainless steel, Steel	•	••	High-performance volatilizing punching medium, leaves a thin corrosion-protection film
	<b>Beruform VSM 506-1</b> 9762822 	-	≥ 62	Aluminum, Brass, Copper, Stainless steel, Steel	•••	-	Production of punching and bending parts
Stainless forming of aluminium	<b>Berucut MQL-A 20</b> 5204309 	26,8	≥ 170	Aluminum, Non-ferrous metals, Stainless steel	••••	-	Synthetic machining oil, especially suitable stain-free machining of sensitive aluminum alloys
	<b>Beruform STO 110</b> 2305409 	45,9	≥ 290	Aluminum, Copper, Steel, Surface plated material	•••	-	High-performance, fully synthetic forming oil for minimum quantity lubrication









• = low ... ••••• = very high

Product	Kinematic viscosity at 40 °C [mm <sup>2</sup> /s]		Materials to be processed	Polar additives		Description
	Flash point approx. [°C]			EP-additives		
<b>Berufilm STE 426</b> 9762932 	-	-	Aluminum, Non-ferrous metals, Stainless steel, Steel, Zinc-plated belt material	••	••	Water miscible forming concentrate for punching, deep drawing and bending, suppresses zinc efflorescence (white rust)
<b>Berufilm STE 5023</b> 9905272 	-	-	Aluminum, Brass, Copper, Steel	•••	•••	Water miscible forming concentrate for punching and deep drawing of non-ferrous metals, forms a finely dispersed, high-performance emulsion, excellent corrosion protection
<b>Berufilm STO 114 ZF</b> 9762562 	72,5	≥ 185	Galvanised steel, Stainless steel, Steel	•••	•••	Medium viscous forming oil with high additive content for medium to demanding forming operations
<b>Berufilm STO 116 ZF</b> 9762632 	100	≥ 185	Galvanised steel, Stainless steel, Steel	•••	••••	Medium viscous forming oil for medium to demanding sheet forming operations with high additive content
<b>Berufilm STO 121 ZF</b> 9762542 	98	≥ 185	Galvanised steel, Stainless steel, Steel	•••	•••••	High-performance oil for difficult to very difficult punching and fine cutting operations on transfer presses, outstanding for minimum quantity lubrication
<b>Berufilm STO 533</b> 9961762 	27	≥ 180	Aluminum, Stainless steel, Steel	••	•	Easy to medium sheet forming operations
<b>Berufilm STO 1268</b> 9660852 	120	≥ 160	Stainless steel, Steel	••••	•••••	High-performance oil for demanding to very demanding punching and fine blanking operations on transfer presses, highly suitable for minimum quantity lubrication
<b>Berufilm STO 1368</b> 8500002 	130	≥ 160	Stainless steel, Steel	••••	•••••	For difficult and the most demanding sheet forming operations, especially fine blanking
<b>Berufilm STO 1568</b> 9762792 	150	≥ 180	Stainless steel, Steel	••••	•••••	Like <b>Berufilm STO 1268</b> , however with higher viscosity

↓ Emulsifiable punching, deep drawing lubricants



↓ Non water miscible punching and deep drawing oils

All indications and values correspond to latest knowledge and do not represent any product specification.

Product	Kinematic viscosity at 40 °C [mm <sup>2</sup> /s]			Flash point approx. [°C]			Materials to be processed			Polar additives	EP-additives	Description
	Product	250	≥ 184	Galvanised steel, Stainless steel, Steel	••••	•••••	Like <b>Berufom STO 1568</b> , however with higher viscosity, not suitable for minimum quantity lubrication					
<b>Berufom STO 2568</b> 9960932 	250	≥ 184	Galvanised steel, Stainless steel, Steel	••••	•••••	Like <b>Berufom STO 1568</b> , however with higher viscosity, not suitable for minimum quantity lubrication						
<b>Berufom STO 3446</b> 9909062 	350	≥ 240	Aluminum, Stainless steel, Steel	••••	•••••	High-performance oil for demanding to highly demanding forming processes, especially deep drawing operations						
<b>Berufom STO 3508</b> 99763029 	350	≥ 145	Galvanised steel, Stainless steel, Steel	–	–	Forming oil for the most demanding of sheet metal forming, long tool lives, good corrosion protection, excellent adhesion to metal surfaces, AW and EP additive						
<b>Berufom XFO 1555</b> 9762972 	150	≥ 150	Galvanised steel, Stainless steel, Steel	–	–	High-performance forming oil for the most demanding of sheet metal forming, very long tool lives, good corrosion protection, excellent adhesion to metal surfaces, synergistic, highly-effective AW and EP additive, chlorine-free						
<b>Berufom XFO 1866</b> 9763032 	180	≥ 155	Galvanised steel, Stainless steel, Steel	–	–	Forming oil for the most demanding of sheet metal forming, very long tool lives, good corrosion protection, excellent adhesion to metal surfaces, synergistic, highly-effective AW and EP additive, chlorine-free						
<b>Berufom XFO 2577</b> 9763042 	250	≥ 160	Galvanised steel, Stainless steel, Steel	–	–	Forming oil for the most demanding of sheet metal forming, long tool lives, good corrosion protection, excellent adhesion to metal surfaces, AW and EP additive, chlorine-free						
	<b>Berufom MF 465</b> 8500012 	40	≥ 180	Aluminum, Non-ferrous metals, Stainless steel, Steel	•••	•••	Processing oil for medium to demanding forming operations, inhibited by non-ferrous metals, outstandingly suited for minimum quantity lubrication					
	<b>Berufom MF 1356</b> 9909032 	130	≥ 195	Aluminum, Non-ferrous metals, Stainless steel, Steel	•••	•••	Processing oil for medium to demanding forming operations, inhibited by non-ferrous metals, outstandingly suited for minimum quantity lubrication					

• = low ... ••••• = very high







Product	Materials to be processed			Kinematic viscosity at 40 °C [mm <sup>2</sup> /s]		Description
	Kinematic viscosity at 40 °C [mm <sup>2</sup> /s]	Flash point approx. [°C]	Materials to be processed	Polar additives	EP-additives	
<b>Beriform STP 50 CA</b> 9816802 	-	-	Stainless steel, Steel	•••••	••••	Mineral oil free high performance paste, allows high forming degrees, washable, outstanding residue behavior
<b>Beriform STP 3734</b> 9961779 	1800	≥ 250	Aluminum, Brass, Copper, Copper alloys, Stainless steel, Steel	••••	•••	Forming paste free of phosphorous, sulfur and mineral oil, for high degrees of forming, water-miscible, excellent residue behavior

Forming pastes











### Wire drawing

The wire drawing lubricants of the BECHEM Unopol and Berudraw series belong to the leading global brands in wire production and processing. Their excellent drawing performance and service life satisfy wire manufacturers all over the world. Through continuous research and development BECHEM ensures the highest level of quality and productivity for all applications in the demanding field of wire production.

Product	Materials to be processed	Kinematic viscosity at 40 °C [mm <sup>2</sup> /s]			Description
		Kinematic viscosity at 40 °C [mm <sup>2</sup> /s]	Polar additives	EP-additives	
<b>BECHEM Unopol F 811</b> 9902022 	Copper, Copper alloys	-	-	-	Combines the advantages of mineral oil containing products and synthetic additives, guarantees a clean system in fine wire drawing (single and multiple draw) up to a final diameter of 0.10 mm, extremely long emulsion service life, excellent lubrication and long service life for the dies
<b>BECHEM Unopol G 560</b> 9905082 	Copper, Copper alloys	-	-	-	High-performance product for rod and medium wire drawing as well as in multiple wire machines up to final diameters of 0.20 mm, for blank, tinned and silver-plated copper, application concentration 5% to 15%, provides excellent lubrication combined with effective cleaning of wire and machine, long service life of the emulsion
<b>BECHEM Unopol S 621</b> 9905439 	Copper, Copper alloys	-	-	-	Universal product for use in medium and fine wire drawing (single and multiple wire machines) up to a final diameter of 0.10 mm, in some cases up to 0.07 mm, made of blank, tinned and silver-plated and nickel-plated copper, excellent cleaning effect, very long service life, water-soluble
<b>BECHEM Unopol S 643</b> 9905649 	Copper, Copper alloys	-	-	-	Like <b>BECHEM Unopol S 803</b> , however with excellent productivity and significantly extended service life of the drawing die



Drawing lubricants for copper and copper alloys

All indications and values correspond to latest knowledge and do not represent any product specification.



Product	Materials to be processed	Kinematic viscosity at 40 °C [mm <sup>2</sup> /s]			Description
			Polar additives	EP-additives	
<b>BECEM Unopol S 803</b> 9905119 	Copper, Copper alloys	-	-	-	Developed for super fine drawing in multiple wire machines up to a final diameter of 0.05 mm, guarantees clean wires and drawing systems as well as an extremely long service life for the drawing solution
<b>BECEM Unopol S KF</b> 9605169 	Copper, Copper alloys	-	-	-	Universal product for use in fine wire drawing (single and multiple wire machines) made of copper, up to a final diameter of 0.05 mm, in some cases up to 0.03 mm, excellent cleaning effect, very long emulsion life, good cooling and lubricating effect, fully water-soluble, meets TRGS 611
<b>BECEM Unopol SP 930</b> 9796201 	Copper, Copper alloys	1,6	-	-	Special product for cleaning the wire after drawing and annealing, for lubrication during the stranding process, applied by spraying and immersion, after evaporation of the carrier medium a very thin lubricating film remains on the wire surface that offers good corrosion protection
<b>BECEM Unopol SPG 623</b> 9905452 	Copper, Copper alloys	-	-	-	Water miscible, special annealing fluid, at an application concentration of 0.5% to 2.0% the product offers an excellent cleaning effect as well as corrosion protection, wire discoloration and spotting
<b>BECEM Unopol U 570</b> 9905222 	Copper, Copper alloys	-	-	-	Universal product for use in rod, medium and fine wire drawing (single and multiple wire machines) up to a final diameter of 0.15 mm of blank, tinned and silver-plated copper
<b>BECEM Unopol AL 560</b> 9906012 	Aluminum, Aluminium alloys, Tin	-	-	-	Suitable for rod drawing and medium wire drawing of EC aluminum and for the production of enameled wires, depending on the application, the concentration varies between 10% and 25%
<b>BECEM Unopol AL 570</b> 9906022 	Aluminum, Aluminium alloys	-	-	-	Drawing emulsion developed for aluminum wire drawing with starting diameters of approx. 3.5 mm and final diameters of 0.10 to 0.80 mm in single and multiple wire machines with continuous annealing process, depending on the application the concentration varies between 10% and 25%
<b>Berudraw AL 3</b> 9762622 	Aluminum, Aluminium alloys	29	-	-	Low-viscous drawing oil for aluminum and aluminum alloy medium wire and fine wire in single and multiple wire spray systems
<b>Berudraw AL 20</b> 9795002 	Aluminum, Aluminium alloys	160	-	-	Medium viscous drawing oil for aluminum and aluminum alloy rod wire and medium wire, for use in spray systems

Drawing lubricants for aluminium and al-alloys

• = low ... \*\*\*\*\* = very high

Product	Materials to be processed	Kinematic viscosity at 40 °C [mm <sup>2</sup> /s]			Description
			Polar additives	EP-additives	
<b>Berudraw AL 105</b> 9808402 	Aluminum, Aluminium alloys	540	–	–	Non water-miscible drawing oil for preliminary drawing of aluminum and aluminum alloys, use in immersion machines, for long oil durability, bright and clean wire surfaces
<b>Berudraw 2291-1</b> 9961819 	Non-ferrous metals, Steel	–	••••	–	Applied undiluted as a paste in single draw processes after coating or liming or in the last drawing box after dry drawing processes as soap solution for a polishing draft
<b>Berudraw 3587</b> 9961259 	Iron, Steel	–	••••	–	Mineral oil free, emulsifiable drawing oil concentrate for drawing blank, galvanized as well as copper-plated or brass-plated steel wire
<b>Berudraw 3779</b> 9961339 	Stainless steel	870	••••	•••••	High-viscosity, non water miscible drawing oil with a high chlorine content for external and internal lubrication of tubes as well as drawing of bars and of stainless steel profiles
<b>Berudraw 3955</b> 9961789 	Non-ferrous metals, Steel	–	••••	–	Soft, water soluble drawing paste with native esters and surface-active substances
<b>Berudraw 4046</b> 9901122 	Stainless steel, Steel	307	••	•••••	Non water miscible drawing oil for cold drawing of blank steel in wet drawing processes
<b>Berudraw D-14 V-S</b> 9804862 	Stainless steel, Steel	10,5	••	•••	Chlorine free, non water miscible special drawing oil for drawing steel and stainless steel wire in fine and super fine drawing processes
<b>Berudraw ZD 818 NEU</b> 9762292 	Stainless steel, Steel	32	•••	••••	For drawing medium to small diameter wire, from medium to small dimensions, enables a long service life of the drawing capstans

↓ Drawing lubricants for steel



Product	Materials to be processed	Kinematic viscosity at 40 °C [mm <sup>2</sup> /s]	Polar additives	EP-additives	Description
<b>Beruforge 152 D</b> 9302209 	Aluminum, Steel	-	••••	•••	Coating lubricant especially developed for cold massive forming of semi-finished steel products, dip application on the blasted blanks
	<b>Beruforge 152 DL</b> 9302309 	Aluminum, Brass, Copper, Stainless steel, Steel	-	••••	•••

Coatings for steel





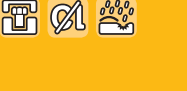



### Cold forming oils

The extreme surface pressures between tool and work piece require high-performance forming agents which are able to build up pressure-resistant layers during the process in order to prevent premature wear, fretting or even breakage of the tools. With the BECHEM products for cold massive forming you can be sure to use the most modern, continuously developed products for demanding forming processes.

Product	Kinematic viscosity at 40 °C [mm <sup>2</sup> /s]	Flash point approx. [°C]	Materials to be processed	Polar additives	EP-additives	Description
<b>Beruform KFP 10</b> 9811302 	64	≥ 180	Stainless steel, Steel	••	••••	Cold forming oil for high requirements, such as very deep cupping operations, very long reductions of high-alloyed steels, application by immersion or spray devices
	<b>Beruform KFP 49</b> 9660062 	36	≥ 180	Steel	•	••
<b>Beruform KFP 95</b> 9660182 	90	≥ 180	Stainless steel, Steel	•••	•••	Chlorine-free cold forming oil for very demanding, multi-stage forming of high-tensile carbon steels and alloyed steels, high tool life, long service life in the coolant tank
<b>Beruform KFP 96</b> 9660202 	101	≥ 170	Stainless steel, Steel	•••	•••	Like <b>Beruform KFP 95</b> , however with a higher performance





Cold forming oils

• = low ... ••••• = very high

Product	Kinematic viscosity at 40 °C [mm <sup>2</sup> /s]		Materials to be processed	Polar additives	EP-additives	Description
		Flash point approx. [°C]				
<b>Berufarm KFP 96 HC</b> 9660662 	80	≥ 180	Stainless steel, Steel	••••	••••	Cold forming oil for extreme requirements with a high additive content, especially suitable for high-tempered steels and stainless steels, considerably reduced formation of residues on formed parts
<b>Berufarm KFP PP-Z</b> 9660562 	115	≥ 180	Stainless steel, Steel	•••••	•••••	Cold forming oil with an extremely high additive and solid lubricant content, excellent tool life with excellent surface qualities, also suitable for replacing chlorine containing products
<b>Berufarm MF 85</b> 9660352 	90	≥ 180	Aluminum, Brass, Copper, Steel	••	••	Chlorine-free multifunction oil with a high additive content for cold massive forming on multiple stage presses, extremely resistant to ageing, improved flushing performance and optimum lubrication properties
<b>Berufarm MF 105-100</b> 9660722 	100	≥ 240	Brass, Steel	-	-	For easy to medium forming processes of steel and brass, also suitable for as machine oil and bed track oil, as well as press oil with minimal tool wear
<b>Berufarm MF 148 NEU</b> 9909052 	110	≥ 195	Aluminum, Brass, Copper, Stainless steel, Steel	•••	•••	Chlorine-free cold forming oil with a high additive content for cold massive forming on multiple stage presses, multi-functional use as machine and forming oil providing constant additive and viscosity level
<b>Berufarm MF 148-68</b> 9660522 	68	≥ 185	Aluminum, Brass, Copper, Steel	•••	•••	Like <b>Berufarm MF 148 NEU</b> , however with viscosity grade 68
<b>Berufarm MF 155</b> 9660842 	-	≥ 200	Aluminum, Brass, Copper, Stainless steel, Steel	•••	•••	Like <b>Berufarm MF 85</b> , however with better performance
<b>Berufarm MF 1136 B</b> 9660942 	110	≥ 200	Aluminum, Brass, Copper, Stainless steel, Steel	•••	•••	Chlorine-free multifunction oil with high additive content for demanding cold massive forming processes
<b>Berufarm MF 1146</b> 9660392 	100	≥ 220	Aluminum, Brass, Copper, Stainless steel, Steel	•••	•••	Like <b>Berufarm 1167 B</b> however, high evaporation resistance and high flashpoint allow forming processes at very high forming temperatures, ideal for products coated with Beruforge

↓ Multifunctional forming oils

All indications and values correspond to latest knowledge and do not represent any product specification.



Product	Kinematic viscosity at 40 °C [mm <sup>2</sup> /s]		Materials to be processed	Polar additives	EP-additives	Description
		Flash point approx. [°C]				
<b>Beruford MF 1167 B</b> 9660382 	-	≥ 195	Aluminum, Brass, Copper, Stainless steel, Steel	•••	•••	Chlorine-free multifunctional oil with high additive content for most demanding cold massive forming processes, especially suitable for products coated with Beruforge
<b>Beruford KFP 22</b> 9814202 	-	-	Stainless steel, Steel	••••	••••	Cold forming oil with extremely high additive content for demanding forming processes, applied pure for complicated work pieces or as additive package to increase the performance of conventional forming oils
<b>Beruford KFP 22 P</b> 9818302 	-	≥ 160	Stainless steel, Steel	••••	••••	Pasty concentrate of active ingredients, auxiliary material for the most difficult forming processes, can also be used as drawing paste in preliminary drawing devices for drawing of cold heading wires
<b>Beruford KFP 810</b> 9660962 	220	≥ 235	Stainless steel, Steel	-	-	Cold forming oil for demanding high-temperature applications, most demanding forming processes on multi-stage presses, pre-heating, long tool lives, good corrosion protection

Additives and forming agents











### Massive forming

With the Berulit and Beruforge product series BECHEM offers a high-performance range of products for massive forming operations which meet the increasing requirements with regard to environmental regulations, process optimisation and process combinations. BECHEM products offer high levels of lubrication, excellent separation qualities and in many cases guarantee surface qualities which do not require any follow-up treatment.

Product	Applications	Dilution ratio	Description
<b>Beruforge 100</b> 4904509 	Coatings/cold massive forming	1:1 – 1:4	Coating lubricant containing MoS <sub>2</sub> , special additives allow forming without phosphate layer
<b>Beruforge 120 AL</b> 4904719 	Complex parts for massive forming, bending, punching, deep drawing	-	Synthetic, aqueous cooling lubricating wax suspension for hot forming of complex components and punching, with good parting properties and wear protection, suitable for die spraying or as coating lubricant

• = low ... ••••• = very high



Product	Applications	Dilution ratio	Description
<b>Beruforge 120 D</b> <small>9301809</small> 	Coatings/cold massive forming	1:2	Wax-containing coating lubricant for cold massive forming, excellent pressure stability through use of special additives, enables forming of non-phosphated semi-finished products
<b>Beruforge 120 DL</b> <small>9301909</small> 	Deep drawing, bending, punching, wire drawing	–	Coating lubricant as drawing paste, suitable for zinc phosphate free semi-finished products, good corrosion protection, easy removal of residues
<b>Beruforge 170</b> <small>9367509</small> 	Coatings/cold massive forming	1:1 – 1:5	MoS <sub>2</sub> -containing coating lubricant with a low particle size, thus excellent surface qualities are achieved
<b>Beruforge 190</b> <small>9367609</small> 	Complex parts for cold massive forming	–	MoS <sub>2</sub> -containing coating lubricant with minimal particle size for forming of complex components, special additives produce good pressure stability and allow high forming levels without using zinc phosphates
<b>Beruforge 191</b> <small>9367619</small> 	Coatings/cold massive forming	1:1 – 1:2	MoS <sub>2</sub> -containing coating lubricant with minimal particle size for temperatures up to 500 °C, for use on non-phosphated semi-finished products
<b>Beruforge 200 CU</b> <small>9367709</small> 	Cooling and lubrication/die forging to max. +1,280 °C	1:1 – 1:2	Graphite-free lubricant for lubricant circulation systems of high-performance forging machines, excellent oil separation, protects against non-ferrous metal corrosion, optimal forming results in forward and backward extrusion processes
<b>Beruforge 350</b> <small>9366209</small> 	Cooling and lubrication, die forging at +1280 °C	1:4 – 1:8	Synthetic, aqueous coolant suspension with excellent parting properties and wear protection for graphite-free spray die spraying up to 1.280 °C on presses without ejectors and hammers
<b>Beruforge 393 G</b> <small>4904209</small> 	Cooling and lubrication/die forging to max. +1,280 °C	1:5 – 1:15	Lubricant with a low graphite content and waxy additives for forming of aluminum and magnesium, tool temperatures from +120 °C to +300 °C
<b>Beruforge 2002 B</b> <small>9301709</small> 	Cooling and lubrication/semi-hot forging at +680 °C to +950 °C, hot and profile rolling	1:1 – 1:10	Graphite-free lubricant for hot and profile rolling of steel and non-ferrous metals, highly suitable for circulation cooling and lubrication in semi-hot forging processes, tool temperatures from +120 °C to +300 °C

All indications and values correspond to latest knowledge and do not represent any product specification.

Product	Applications	Dilution ratio	Description
<b>Beruforge 2450 B</b> 9303809 	Circulation cooling and lubrication in semi-hot forging at +680°C to +950 °C, die forging at +1280 °C, extrusion	1:1 – 1:10	Graphite-free lubricant for extrusion of steel and non-ferrous metals, highly suitable for circulation cooling and lubrication in semi-hot forging processes, tool temperatures from +680°C to +950°C, die forging up to 1280°C
<b>Beruform Z1</b> 9010949 	Cold pressing, drawing	–	Microfine powder on MoS <sub>2</sub> basis for cold calibration of forging parts with pre-finished surfaces and for pushing-in /pushing-out of dies
<b>Berulit 366</b> 9422709 	Massive forming	1:5 – 1:10	Synthetic, water soluble, graphite-free coolant for die spraying, excellent lubricating and parting properties, for die forging up to 1.280 °C of complex components
<b>Berulit 392</b> 9009839 	Circulation cooling and lubrication in semi-hot forging at +680°C to +950 °C, die forging at +1280 °C, extrusion	1:1 – 1:10	Graphite-free coolant for spray application in die forging up to 1,280 °C as well as extrusion, excellent flow properties, good release effect and excellent wear protection
<b>Berulit 630</b> 9413912 	Cooling and lubrication/die forging up to max. +1280 °C	1:5 – 1:15	Graphite containing oil-in-water emulsion with low particle size for forming of aluminum and other non-ferrous metal alloys, suitable for hot profile rolling of steel and non-ferrous metals, tool temperatures from +100 °C to +350 °C
<b>Berulit 740-88</b> 9010522 	Cooling & lubrication, die forging to max. +1.280 °C	1:1 – 1:4 with mineral oil	Suitable for die forging and hot forging of steel and brass alloys, especially for the production of hollow parts
<b>Berulit 906 HP</b> 4905809 	Cooling and lubrication/die forging to max. +1,280 °C	1:10	Graphite containing lubricant with a minimal particle size for extreme applications in die forging, tool temperatures from +120 °C to +350 °C
<b>Berulit 909</b> 9412609 	Circulation cooling and lubrication in semi-hot forging at +680 °C to +950 °C, die forging at +1280 °C	1:1 – 1:10	Graphite containing, ammonia free coolant for spray application in die forging in loss or circulation lubrication up to 1,280 °C, excellent release properties and excellent wear protection, high solids content, suitable for extreme applications
<b>Berulit 912 HP</b> 4900209 	Cooling & lubrication, die forging to max. +1.280 °C	1:1 – 1:10	Universal lubricant for circulation cooling and lubrication in semi-hot forging processes, tool temperatures from +120 °C to +350 °C

Masterdraw and Kubitrac are brands of ETNA PRODUCTS INC.



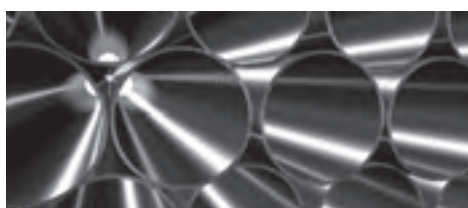

Product	Applications	Dilution ratio	Description
<b>Berulit 913</b> 9412009 	Coatings/semi-hot forging to max. +950 °C, hot and profile rolling	1:1 – 1:4	Coating lubricant for semi-hot forging, prevents scaling on the surface, high temperature stability, through special additives also highly suitable for hot and profile rolling of steel and aluminum
<b>Berulit 935</b> 4903409 	Coatings/semi-hot forging to max. +950 °C	1:1 – 1:4	Coating lubricant for semi-hot forging, prevents scaling on the surface, high temperature stability
<b>Berulit 935 H</b> 4905009 	Coating of unfinished parts, semi hot forging at max. +950 °C	–	Graphite containing coating lubricant with special graphite mixture for semi-hot forging up to 950 °C, excellent parting properties and wear protection, prevents surface scaling based on high temperature stability







### Tube drawing

BECHEM tube drawing products are used for forming of tubes, hollow profiles or round bars, no matter whether blasted, annealed or pickled materials are involved. The tube drawing lubricants are suitable for external as well as internal lubrication. A large variety of technical processes is covered with this range of products.

Product	Applications	Kinematic viscosity at 40 °C [mm <sup>2</sup> /s]	Density at 20 °C [g/cm <sup>3</sup> ]	Description
<b>Kubitrac 2508 EB</b> 9961202 	Pilger rolling	–	0,935 – 0,965	Water miscible high-performance rolling oil concentrate for pilgering of tubes made of copper and copper alloys, the milky-white, heat-stable emulsion enables excellent lubrication results, high pilgering speeds and long tool life
<b>Masterdraw 560</b> 9860072 	Drawing: copper-nickel, brass	125	0,86 – 0,89	For internal lubrication (ID) for copper tube drawing (finish draws) of thin to medium wall thicknesses
<b>Masterdraw EBE 110</b> 9860302 	Hot pressing: copper alloys, copper-nickel alloys	–	1,08 – 1,1	Low-viscous, water based medium for hot forming and forging processes, oil and graphite free

↓ Copper tube production

All indications and values correspond to latest knowledge and do not represent any product specification.

Product		Applications	Kinematic viscosity at 40 °C [mm <sup>2</sup> /s]	Density at 20 °C [g/cm <sup>3</sup> ]	Description
Aluminium tube production	<b>Masterdraw EBE 270</b> 9860312 	Drawing: copper-nickel, brass	3000	0,87 – 0,89	For drawing of profiles, slugs and tubes of non-ferrous metal, brass and copper-nickel alloys on spinner blocks and drawing benches, low to high wall thicknesses
	<b>Masterdraw 558 SC</b> 9860122 	Drawing: copper-nickel, brass	–	0,86 – 0,89	Drawing of aluminum tubes, especially on spinner blocks (bull blocks) and drawing benches, also suitable for multiple drawing processes
	<b>Masterdraw EBE 430</b> 9860352 	Drawing: copper-nickel, brass	4,5	0,8 – 0,85	Especially developed for finish draws inside aluminum tubes with medium to low wall thicknesses
Steel tube production	<b>BEICHEM Starlit EM-MA-DF</b> 9401339 	Forming	–	1,065 – 1,085	Flame retardant, water miscible concentrate and forming agent, stable solution, optimal biostability
	<b>Berufarm STO 3009 C</b> 9762192 	Tube drawing	3700	1,34 – 1,36	Highly viscous, high chlorine content drawing oil, for drawing of tubes and profiles made of CrNi steels, high-temperature resistant steels and titanium



All indications and values correspond to latest knowledge and do not represent any product specification.



# Cleaners

In the metal-working industry, cleaning workpieces and semi-finished products is an important work step during the production process. Insufficient or incorrect cleaning often leads to considerable product deficiencies and faults. The selection of the best-possible cleaner depends on the material to be cleaned, the system technology used and the type of impurities.

## CORE RANGE

Ask about our local custom solutions



## Cleaners

BECHEM offers the suitable aqueous and solvent containing products for the various materials and cleaning processes involved in metal working.

	Product		Materials	Applications	Kinematic viscosity at 40 °C [mm <sup>2</sup> /s]	Flash point approx. [°C]	Description
	Product Name	Code					
Cleaners based on synthetic hydrocarbons	<b>Beruclean ECO</b>	2000202	Elastomers, Ferrous metals, Non-ferrous metal, Plastic	Ferrous and non-ferrous metals, stone, marble, slabs, elastomers, plastics, textiles, removes oil, fats, waxes, resins, bitumen, tar, oil carbon, paints and varnishes that are not fully hardened yet	–	≥ 65	Universal cold cleaner, free of aromatic hydrocarbons, virtually odorless, strong dissolution effect, good cleaning effect, quickly biodegradable according to OECD 301 F, A7, H1 registered, Halal and Kosher certified
	<b>Beruclean H1 Spray</b>	5301202	–	Spray cleaning (spraying also possible while spray can is held upside down)	–	–	Degreaser and brake cleaner, removes all types of oil and grease contamination as well as not yet hardened paints and coatings, dissipates without residues, excellent corrosion protection, H1 registered
	<b>Beruclean S 114 ECO</b>	3703509	All types of metal, Paints, Plastic, Rubber	Degreasing of metal parts and semi-finished products, tools, chains, removal of oils, resins, greases, manual wash stations, machine cleaning	4,2	≥ 180	Cold cleaner based on renewable raw materials, removes oils, resins, greases, high flash point, slight corrosion protection
	<b>Beruclean S 214</b>	9605302	–	Degreasing of metal parts and semi-finished products, for cleaning equipment, tools, engines, chassis, underbodies, workshop floors, dewaxing of new vehicles, removal of processing oils, corrosion protection media and waxes	2	≥ 62	Emulsifiable cold cleaner to remove processing residues, removable by water jet after exposure
	<b>Beruclean S 4033</b>	5106712	–	Degreasing of metal parts and semi-finished products, for cleaning equipment, tools, engines, tank systems, chains, vehicles, removal of processing oils that are not mixed with water, corrosion protection media and waxes	1,35	≥ 62	Mixture of aromatic free hydrocarbons, narrow vacuum cut, dries quickly, virtually odorless
Concentrates for aqueous cleaning	<b>Beruclean 111 EHF</b>	9963609	Ferric, Steel	Spray cleaning (+50 °C - +80 °C), ultrasonic cleaning (+50 °C - +80 °C), immersion cleaning (+50 °C - +80 °C)	–	–	Universal implementation, highly alkaline aqueous cleaner for steel and ferrous materials
	<b>Beruclean 113 EMF</b>	9964249	Aluminium, Cast iron, Non-ferrous metal, Steel	Spray cleaning (+30 °C to +60 °C), ultrasonic cleaning (+30 °C to +70 °C), immersion cleaning (+30 °C to +80 °C)	–	–	Universal, mildly alkaline, aqueous cleaner for steel and ferrous materials, especially suitable for aluminium and non-ferrous metals, achieves optimal surface passivation
	<b>Beruclean 3050</b>	9964309	Ferric, Steel	Steel and iron materials, aluminum, slabs, tiles, plastic surfaces, equipment, industrial floors, engines, vehicles, machinery	–	–	Mildly alkaline, intensive and special cleaner for industrial contamination, neutral to paints, rubber seals, plastics, textiles and aluminum, high profitability thanks to extremely low consumption, generates minimal foam

Product	Materials	Applications	Kinematic viscosity at 40 °C [mm <sup>2</sup> /s]		Description
				Flash point approx. [°C]	
<b>Beruclean 3305</b> 9962939 	Aluminium, Non-ferrous metal, Steel, Zinc	Immersion and spray cleaning starting at +50 °C	–	–	Spray and immersion cleaner with integrated protection for non-ferrous metals and steel
<b>Beruclean 3849</b> 9962859 	Ceramic, Glass, Stainless steel	Immersion degreasing (+30 °C to +80 °C), manual cleaning, diluted in high-pressure cleaners	–	–	Liquid, phosphorous cleaning concentrate, removes organic and inorganic deposits, cleaning of acid-resistant materials, has anti-bacterial effect because of the very low pH-value
<b>Beruclean 5000</b> 9960159 	Grey cast iron, Steel	Immersion, spray, flood injection and ultrasonic cleaning as well as passivation (+50 °C to +70 °C for all processes)	–	–	Neutral cleaner, low foaming, excellent dust-carrying capacity, very good corrosion protection, optimal cleaning results
<b>Beruclean 5005</b> 9960179 	Aluminium, Grey cast iron, Non-ferrous metal, Steel	Immersion, spray, flood injection and ultrasonic cleaning as well as passivation (+50 °C to +70 °C for all processes)	–	–	Neutral cleaner, low foaming, excellent dust-carrying capability, excellent corrosion protection, excellent cleaning results especially for oil and ultrafine particles
<b>Beruclean 5100</b> 9960209 	Grey cast iron, Non-ferrous metal, Steel	Immersion, spray, flood injection and ultrasonic cleaning as well as passivation (+20 °C to +70 °C for all processes)	–	–	Low-temperature cleaning agent, low foaming, excellent dust-carrying capacity, good corrosion protection, optimal cleaning results
<b>Beruclean 5124</b> 9960169 	Aluminium, Cast iron, Non-ferrous metal, Steel	Immersion, spray, flood injection and ultrasonic cleaning as well as passivation (+50 °C - +70 °C for all processes)	–	–	Neutral cleaner, low foaming, excellent dust-carrying capability, excellent corrosion protection, optimal cleaning results, demulsifying
<b>Beruclean 5200</b> 9960189 	Aluminium, Non-ferrous metal, Steel	Immersion cleaning starting at +40 °C, special cleaner for ultrasonic cleaning	–	–	Neutral cleaner, low foaming, excellent dust-carrying capability, excellent corrosion protection, optimal cleaning results, demulsifying

All indications and values correspond to latest knowledge and do not represent any product specification.





# Corrosion protection

Cleaning and corrosion protection procedures individually tailored to each other can contribute to significant cost reductions and economic efficiency of plant systems. BECHEM has developed a product range covering solvent, oil and water-based products for various applications in temporary corrosion protection.

**CORE RANGE**









Ask about our local custom solutions



## Corrosion protection

Whether dewatering fluid, anti-corrosion oil or anti-corrosion concentrate for aqueous cleaners – BECHEM offers the right form of temporary protection for every requirement.

Product	Kinematic viscosity at 40 °C [mm <sup>2</sup> /s]	Flash point approx. [°C]	Type of protective film	Layer thickness approx. [µm]	Period of protection internal storage	Period of protection external storage	Description	
Dewatering fluids 	<b>Beruprotect 25 S</b> 9960702 	-	≥ 62	like vaseline	3	9–12 Months	3–6 Months	Good creeping properties, forms a high-performance film, free of aromatic hydrocarbons and heavy metals, dries quickly, easy to degrease
	<b>Beruprotect 30 W</b> 9761592 	-	≥ 62	waxy	4	12–15 Months	6–8 Months	Very strong waxy corrosion protection film for highest requirements imposed on temporary prevention, suitable for overseas transports, good dewatering properties, free of aromatic hydrocarbons and heavy metals
	<b>Beruprotect DW 5 V</b> 9960752 	-	≥ 62	like vaseline	0,7	2–3 Months	-	Excellent dewatering properties, very thin, vaseline-like, non resinous film, free of aromatic hydrocarbons and heavy metals
	<b>Beruprotect DW 12 V</b> 9761582 	-	≥ 62	like vaseline	1	9–12 Months	3–6 Months	Universal product, compensates acidic ingress after galvanic processes, forms a thin, vaseline-like and stable film, excellent dewatering properties, free of aromatic hydrocarbons and heavy metals
	<b>Beruprotect DW 20 M</b> 9761622 	-	≥ 62	oily	3	6–9 Months	2–3 Months	Good dewatering properties when displacing aqueous process agents, forms an oily, glossy film, impregnation oil for sintered metals, free of aromatic hydrocarbons and heavy metals
Anti-corrosion oils 	<b>Beruprotect M 6</b> 9960652 	6	≥ 125	oily	-	2–3 Months	-	Highly viscous, anti-corrosion oil with creeping properties for preservation of small parts and bulk goods
	<b>Beruprotect M 20</b> 9964482 	20	≥ 155	oily	-	4–5 Months	-	For preservation of small parts, bulk goods, as well as strip stock
	<b>Beruprotect M 40</b> 9960662 	40	≥ 170	oily	-	6–8 Months	2–3 Months	Oil for polishing and corrosion protection with forming capability, suitable for straightening steel bars

Product	Kinematic viscosity at 40 °C [mm <sup>2</sup> /s]		Flash point approx. [°C]	Type of protective film	Layer thickness approx. [µm]	Period of protection internal storage	Period of protection external storage	Description
<b>Beruprotect M 50</b> 9969832 	50	≥ 170	oily	–	8–10 Months	3–4 Months		Oil for polishing and corrosion protection with forming capability, suitable for preservation of strip stock and for straightening steel bars and tubes
<b>Beruprotect Spray</b> 5310809 	–	–	waxy	20–30	up to 3–4 years	Up to 2 years		Solvent containing protective wax for long-term rust prevention, outstanding adhesive properties, also suitable for salt water atmosphere 
<b>Beruprotect WM 190 M</b> 9611722 	125	–	oily	–	up to 12 months, depending on concentration	–		Water-miscible anti-corrosion concentrate, application temperature range +20 °C to +60 °C, forms an oily, self-repairing film with creeping properties
<b>Beruprotect WM 3620 W</b> 9960729 	–	–	waxy	–	2-9 months, depending on concentration	1-3 months, depending on concentration		Wax/oil dispersion, can be applied undiluted or diluted with water at temperatures up to +60 °C, forms a waxy, resistant film
<b>BECEM High-Lub SW 2</b> 9004372 	100	–	pasty	–	up to 2 years	Up to 1 years		Corrosion protection grease for roller bearings, plain bearings, and ropes, for aggressive ambient conditions, extremely high level wear protection through EP additives, water-resistant, excellent corrosion protection, excellent pumpability 
<b>BECEM Unopol SV 2 KF</b> 9004222 	100	–	pasty	–	–	Up to 10 years		Anti-corrosion grease especially for overhead cables, high thermal stability, protects against aggressive media, water repellent
<b>Beruprotect Rope Dressing</b> 9255101 	–	≥ 140	–	–	–	–		Wire rope lubricant, fluid, good creeping properties, excellent wear and corrosion protection, outstanding adhesion, excellent wetting properties

Water miscible corrosion protection

Anti-corrosion greases, pastes and sprays

Technical information.



“Rely on BECHEM. We are happy to provide you with support and consultation in matters of tribology.”

# We are partners.

## **Tailored to your applications**

In collaboration with our customers, we adapt existing formulas to new requirements or develop entirely new, often unique special solutions. These tailored lubricants enable our customers to streamline their processes and save money. We achieve the best results with close collaboration, internal knowledge transfer and engineering expertise.



The BECHEM Avantin range of water-miscible cooling lubricants was developed to achieve top efficiency for all metal machining processes.

## Customer events and seminars

Besides answering application-related questions, we also offer numerous seminars and events to convey the latest insights in lubrication technology and tribology, fostering exchange between research and practice.



## Tailored to your brand – Private Label

Our many lubrications also prove effective as private labels as well as service and care products for renowned lubrication manufacturers, making a direct or indirect contribution to the success of our customers, for example as an after-sales product.



## Technical service

BECHEM provides regular service inspections as well as special maintenance support by our world-wide operating team of well trained technicians. The BECHEM service package ranges from monitoring running-in processes to lubrication management to analysis of lubricant samples.



## Application consultation

We share our expertise to solve lubrication-related matters and help our customers become more efficient. We support them across the globe with comprehensive service and targeted consultation by experienced application engineers. In addition to lubricant analysis, construction parts, materials or process fluids are tested by means of modern chemical-physical appliances in our laboratory within a short period of time.

# We analyse for our customers.

In many applications lubricants and lubricant systems are already an integrated component and can no longer be considered separately. The product success depends on how the lubricant is tailored to the specifications. In this context a high-performance analysis is of utmost importance.

When developing lubricants an important factor is flow properties in the service temperature range. To measure these rheological characteristics of our products most modern rheometers and viscosimeters are used.

In the BECHEM laboratories modern analytical methods such as thermogravimetry and differential scanning calorimetry are applied for quick and efficient analysis of products and raw materials in the high temperature range. Another focus is the characterisation of dispersions which are nowadays required for various lubricant applications. A defined particle size distribution is an especially important quality aspect for solid lubricants and microcapsule containing lubricants and coatings. Besides different microscopes also laser diffraction is applied for this purpose.



The laboratory test shows the water separation capability of various lubricating oils after five minutes. To the left is the non-optimized, commercially available circulating oil with process water. In the middle is standard oil with process water and to the right is the BECHEM Ovitool KT 460 S optimized for the process water with an outstanding water separation value.



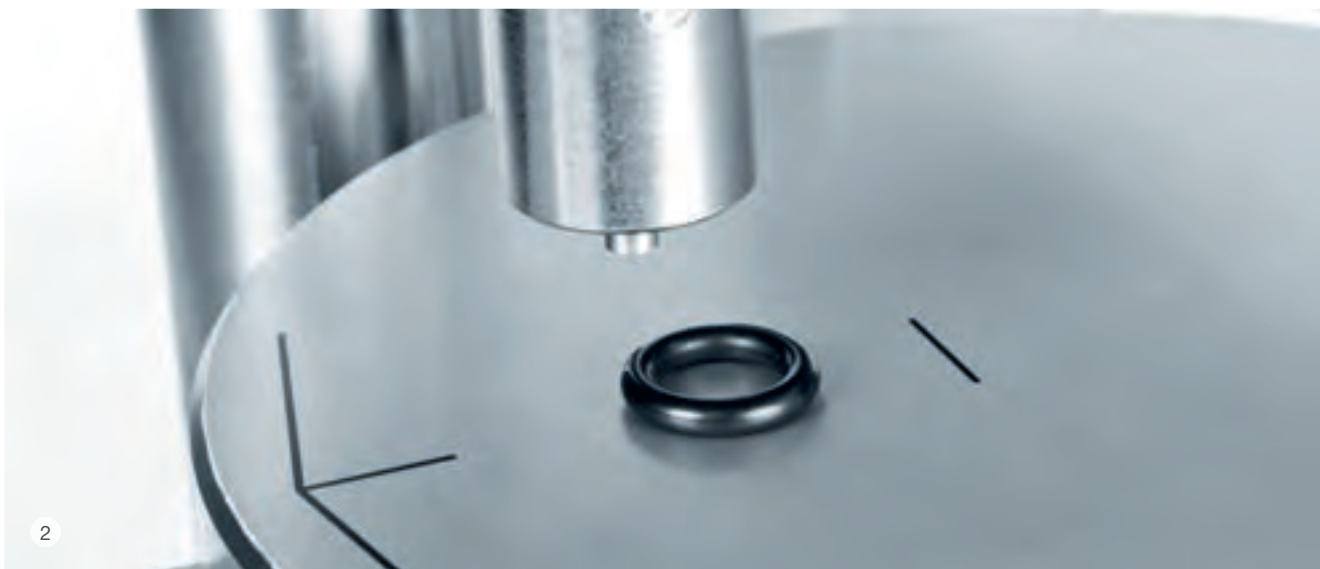

For the manifold surface examinations of construction parts, semi-finished products and raw materials microscopic analyses are essential today. In their analysis BECHEM uses the highly suitable method of infrared microscopy in addition to the photo-optical microscopes.

Beyond the classical lubrication of metal materials the use of lubricants is of growing importance in case of contact with plastics. In this regard the compatibility between lubricant and polymer material is an important requirement. In our BECHEM laboratories a variety of test rigs to confirm this material compatibility is available.



- 1 Analysis of water content
- 2 Hardness test of polymer materials
- 3 Penetrometer to determine consistency of grease
- 4 Fully automatic titration system for chemical analysis

# We test for our customers.

In addition to lubricant analysis the testing of our customers' construction parts or even complete construction groups are of growing importance within the lubricant development.

The long-term effects of realistic impacts, e.g. climatic conditions such as humidity and temperature, which influence the lubricant or construction group, have to be determined within a short period of time. In our BECHEM technical center we have the modern test equipment for this purpose. In our test facilities we can simulate a variety of operating conditions for lubricants used worldwide.





In cooperation with our customers and partners various test systems have been developed in research projects. The integration of our customers in the development of lubricants is an essential part for future problem solving. For developing comprehensive concepts we – and thus our customers – are supported by competent partners.

In addition to cooperation with universities and academies BECHEM has excellent contacts to industrial partner companies in the dosing and feeding technology, measurement and control technology, process and coating technology.

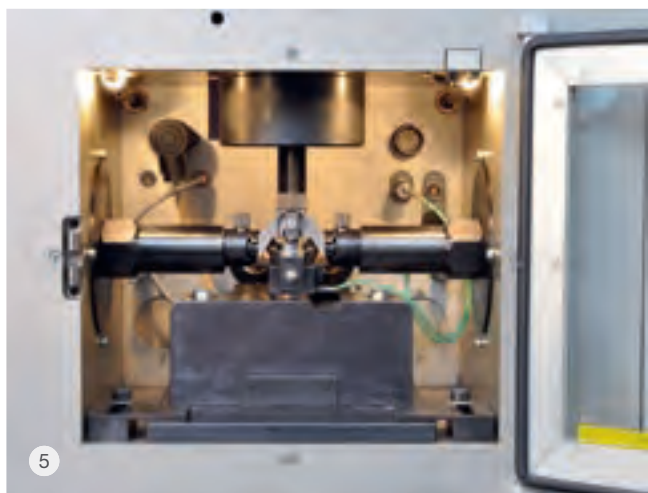

Comprehensive know-how to find the solution to your problems!

- 1 Constant velocity joint test rig
- 2 Torque test rig
- 3 Preparation of flow pressure measurement
- 4 Infrared microscope
- 5 Translatory oscillation test rig (SRV)

# We provide information and consultation.

[www.bechem.com](http://www.bechem.com)

On the BECHEM website, you will find our up-to-the-minute product data in six languages available at the click of a button. We also offer current company news, an overview of all trade fair dates, our customer magazine "Carl" and information on the global BECHEM Group.

## Brochures

The comprehensive BECHEM range of lubricants is featured in many specialized brochures that answer many detailed questions and provide additional information. Ask your contact about our brochures or download them from our website. They are available in up to six languages.

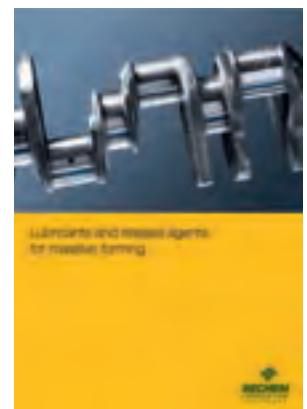
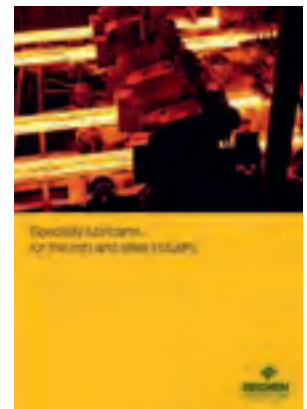
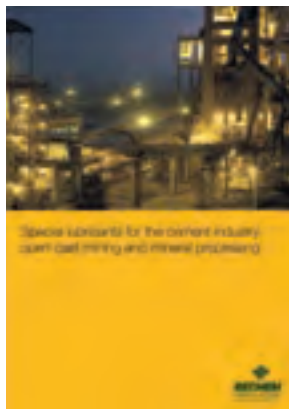



# Award-winning.

We offer our customers from the automotive industry a global partnership in the fields of lubricant development and production so they can be

continuously adapted to ever changing requirements. The result: high performance lubricants approved by renowned automobile manufacturers

and their suppliers and recommended for production.

## Automotive qualifications and references

Brose Group 55.1

Brose Group 53.2

Daimler DBL 6827.42

Fiat Specification 9.55580 Gras V

Ford WSD-M1C 234 A2

Ford WSS-M1C 238 B

Ford WSS-M1C 253 A2

GM 9986237

GM 9986248

GM W16531-Type 4

GM W16531-Type 5

VW-TL 52150

VW-TL 52141

VW-TL 778 A

VW-TL 778 B

BJA

BMW Group

Bosch

Boshoku Automotive

Daimler

Delphi Automotive

Edscha

Faurecia

Grammer

HELAG

Jaguar

Johnson Controls

Kiekert

Kostal

Lear Corporation

Porsche

SAIA-Burgess

Siber

Stoz

TRW

Valeo

BEICHEM lubricants for the food industry meet all the standards and requirements placed on modern products.

They comply with the strict regulations of the international organisations for product testing and certification.

### H1

Identification of food grade lubricants, i. e. lubricants which can be applied where incidental food contact cannot be excluded.

### 3H

Identification of release agents which are used in food production to prevent adhesion of food stuffs (direct food contact is allowed).

### Kosher

Identification of products which are classified as "kosher" (suitable, clean) according to the Jewish dietary laws.

### H2

Identification of lubricants for the general use in the food processing industry, provided food contact is excluded.

### Halal

Identification of products which are classified as "halal" (legal) according to the Islamic dietary regulations.

### ISO 21469

International standard which specifies the hygiene requirements for the formulation, manufacture and use of lubricants where incidental food contact cannot be excluded.

## Awarded

High quality lubricants are indispensable products which are worth their investment, they are winners of prestigious awards – by making a decisive contribution to performance, energy efficiency and sustainability of products and processes.



Award for Berufluid – a joint project with Fraunhofer Institute IVV and IWF Braunschweig.

BECEM wins award for tailored solutions in the premium vehicle sector.



BECEM as an award-winner is one of the 20 most innovative companies in North Rhine-Westphalia.

BECEM wins the award for innovative lifetime lubrication of different vehicle components.



BECEM wins the NRW 2015 Efficiency Award for innovative and resource-efficient coating in cold massive forming.

# Special lubricants for automotive systems and system components.

## Legend:

- Noise Damping
- Plastic Lubrication
- Electrical Contact Lubrication
- Chassis Lubrication
- Special Components

## Electric parking brake, handbrake cable

- Berulub FR 16
- Beruplex LO 21
- Berulub FR 43
- Berutox VPT 64-2
- Berulub XP 746

## Panels

- Berucoat AK-Series (Anti Friction-Coatings)
- Berulub ND-Fluids
- Berutox VPT 64-2
- Berulub ND-Dispersions
- Berusoft-Series

## Window regulator

- BECHEM High-Lub LH 2
- Berulub FR 16
- Berulub FR 32-21
- Berulub XP-Series

## Sunroofs

- Berulub FR 16
- Berulub FR 43
- Beruplex LG 21 F
- Beruplex LG 1-30
- Berusoft-Series

## Door trim

- Berucoat AK-Series (Anti Friction-Coatings)

## Headrests, sun visors, jalousies, cup holder

- Berulub FR 16
- Berulub FR 43
- Berulub HFO 1

## Seat systems

- Berutox VPT 64-2
- Berulub XP 3000

## Power lift gates

- Berulub FR 16



## Motor management

- Berulub FZ 1 E 3

## Belt tensioning systems

- Berusil FO 36-2

## Piston

- Berucoat AF 291

## Braking systems

- Berulub FE 16
- Beruplex LG 21 F

## CV joints

- BECHEM GKN HTBJ
- Berulub CVH 170
- Berulub CVN 140

## Ball joints

- Berulub FW 700
- Berulub SSG 46

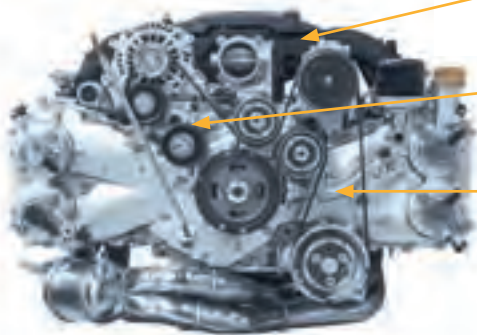



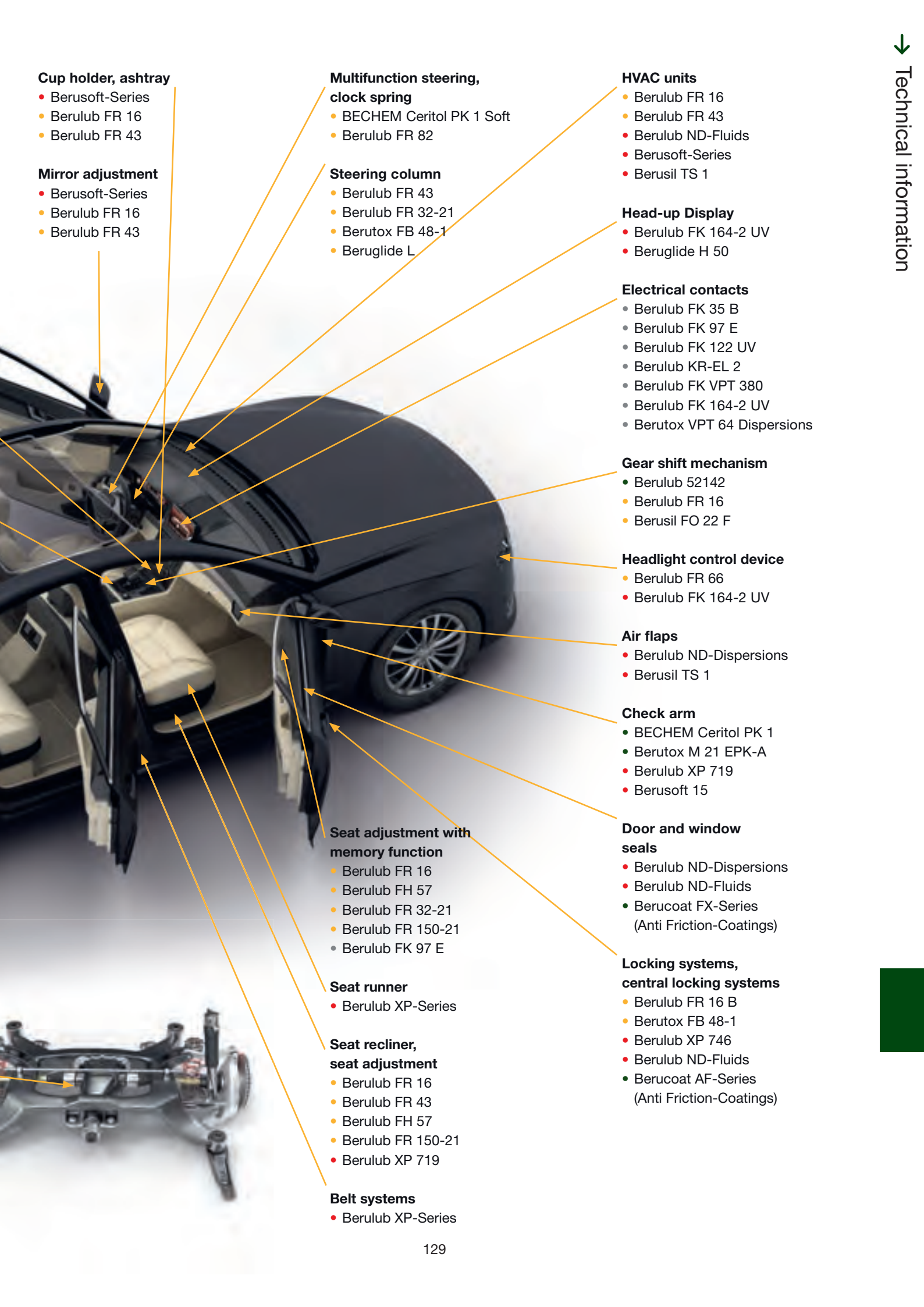

**Cup holder, ashtray**

- Berusoft-Series
- Berulub FR 16
- Berulub FR 43

**Mirror adjustment**

- Berusoft-Series
- Berulub FR 16
- Berulub FR 43

**Multifunction steering, clock spring**

- BECHEM Ceritol PK 1 Soft
- Berulub FR 82

**Steering column**

- Berulub FR 43
- Berulub FR 32-21
- Berutox FB 48-1
- Beruglide L

**HVAC units**

- Berulub FR 16
- Berulub FR 43
- Berulub ND-Fluids
- Berusoft-Series
- Berusil TS 1

**Head-up Display**

- Berulub FK 164-2 UV
- Beruglide H 50

**Electrical contacts**

- Berulub FK 35 B
- Berulub FK 97 E
- Berulub FK 122 UV
- Berulub KR-EL 2
- Berulub FK VPT 380
- Berulub FK 164-2 UV
- Berutox VPT 64 Dispersions

**Gear shift mechanism**

- Berulub 52142
- Berulub FR 16
- Berusil FO 22 F

**Headlight control device**

- Berulub FR 66
- Berulub FK 164-2 UV

**Air flaps**

- Berulub ND-Dispersions
- Berusil TS 1

**Check arm**

- BECHEM Ceritol PK 1
- Berutox M 21 EPK-A
- Berulub XP 719
- Berusoft 15

**Door and window seals**

- Berulub ND-Dispersions
- Berulub ND-Fluids
- Berucoat FX-Series (Anti Friction-Coatings)

**Locking systems, central locking systems**

- Berulub FR 16 B
- Berutox FB 48-1
- Berulub XP 746
- Berulub ND-Fluids
- Berucoat AF-Series (Anti Friction-Coatings)

**Seat adjustment with memory function**

- Berulub FR 16
- Berulub FH 57
- Berulub FR 32-21
- Berulub FR 150-21
- Berulub FK 97 E

**Seat runner**

- Berulub XP-Series

**Seat recliner, seat adjustment**

- Berulub FR 16
- Berulub FR 43
- Berulub FH 57
- Berulub FR 150-21
- Berulub XP 719

**Belt systems**

- Berulub XP-Series

# Process media for metal removal and forming technology.

## FRONT AXLE ASSEMBLY

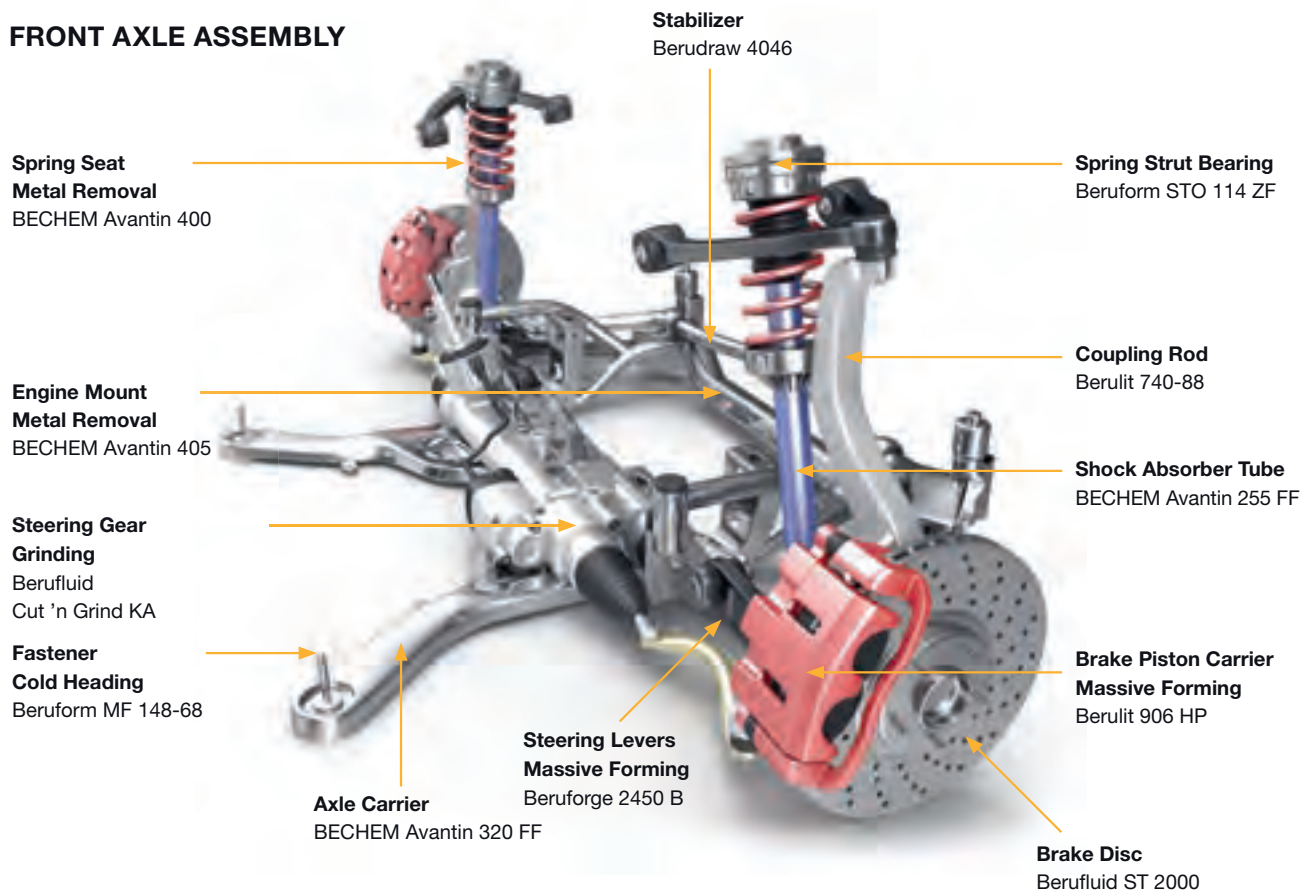

## REAR AXLE ASSEMBLY

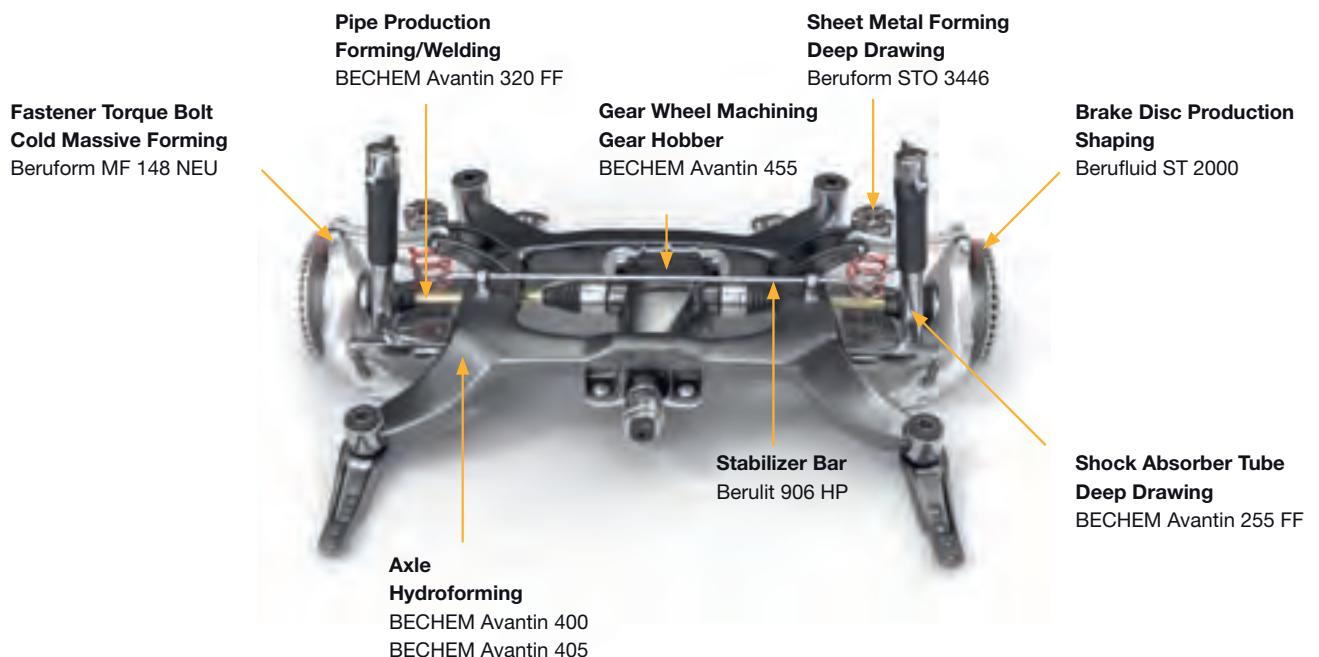

## AUTOMATIC TRANSMISSION ASSEMBLY

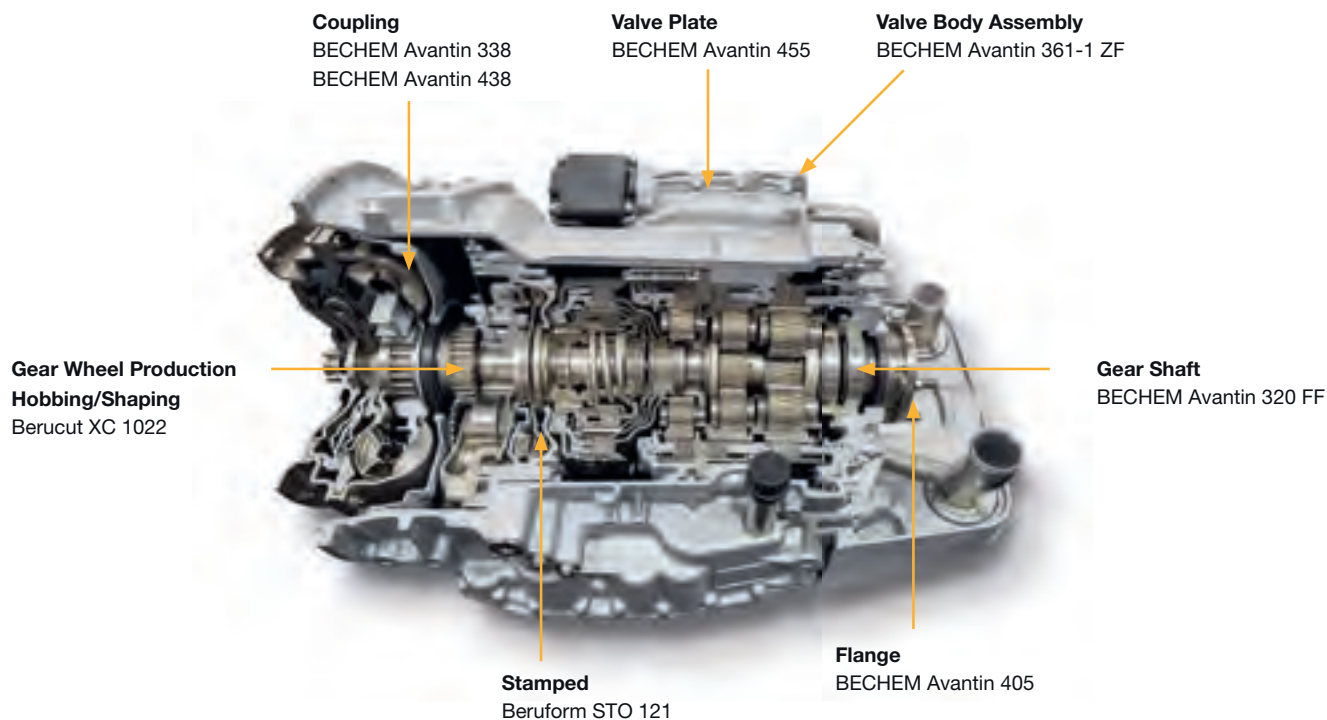

## WIRING SYSTEM



## Viscosity-Temperature-Diagram of Selected Base Oils

The diagram shows the viscosity-temperature-behaviour of various base oil types. For this purpose, characteristic representatives of each type were selected. Within the

type categories strong deviations of the viscosity-temperature-behaviour are possible.

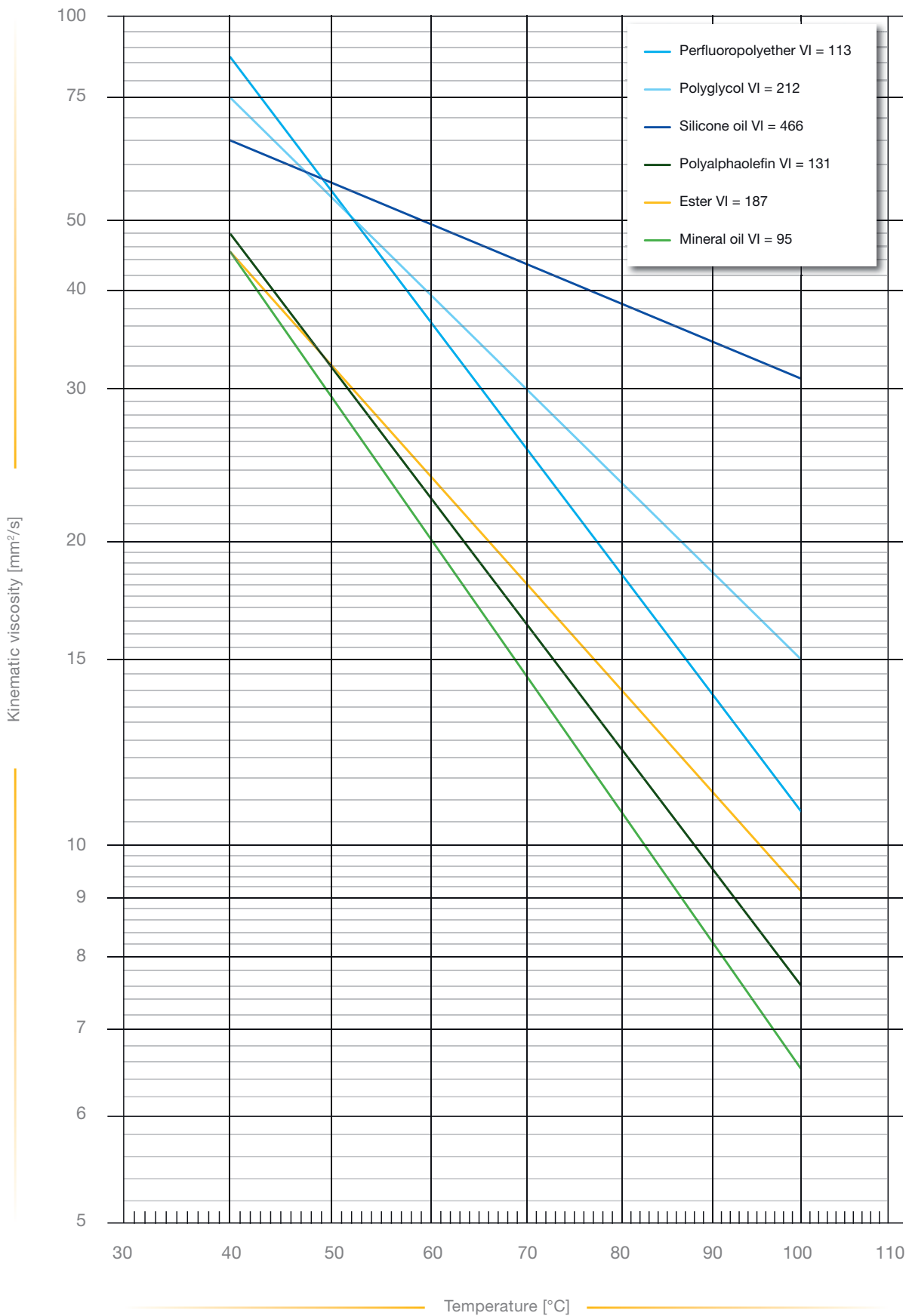

## NLGI-Grades

The classification of lubricating greases according to their consistency, proposed by the National Lubricating Grease Institute (NLGI), is an international standard and was adopted as national standard in Germany by DIN 51818. To determine the NLGI-grade, the cone penetration (worked penetration after 60 double strokes at +25 °C) is measured according to DIN ISO 2137. The penetration of a standardised cone and

shaft in a predefined quantity of lubricant obtained within 5 seconds is measured. In case of soft greases the cone will penetrate deeper into the grease (high penetration figure), if the grease is stiffer the cone will penetrate less deep (lower penetration figure). The classification will then be done based on the penetration depth, given in 0,1 mm units.

Consistency classification acc. to DIN 51818	Worked penetration acc. to DIN ISO 2137	Description of consistency	Application
000	445 - 475	fluid	flowable (semi-fluid) greases, used in gears and central lubrication systems
00	400 - 430	low fluidity	
0	355 - 385	semi-fluid	
1	310 - 340	very soft	roller and plain bearing greases
2	265 - 295	soft	
3	220 - 250	semi-hard	
4	175 - 205	almost hard	sealing greases
5	130 - 160	hard	
6	85 - 115*	solid	block grease

\* refers to the unworked penetration

## ISO VG-Grades

DIN ISO 3448 classifies fluid industrial lubricants into viscosity grades (ISO VG-grades). Basis is the kinematic viscosity at +40 °C. A tolerance range of +/-10 % from the mid

point is allowed. For example, a hydraulic oil of the HLP grade with a viscosity of 46 mm<sup>2</sup>/s at +40 °C is called HLP ISO VG 46.

ISO viscosity-grade (ISO VG-grades)	Mid point viscosity mm <sup>2</sup> /s at +40 °C	Viscosity limits mm <sup>2</sup> /s at +40 °C		Examples of application
2	2.2	1.98	2.42	Spindle oils
3	3.2	2.88	3.52	
5	4.6	4.14	5.06	Honing, grinding and spindle oils
7	6.8	6.12	7.48	
10	10	9.00	11.0	Honing, grinding, cutting and spindle oils
15	15	13.5	16.5	Cutting, grinding, deep drilling and broaching oils
22	22	19.8	24.2	Cutting, grinding, machining and hydraulic oils
32	32	28.8	35.2	
46	46	41.4	50.6	Drawing, forming, broaching, hydraulic and slideway oils
68	68	61.2	74.8	
100	100	90.0	110	Drawing, forming, fine blanking, hydraulic and gear oils
150	150	135	165	Drawing, forming and gear oils
220	220	198	242	
320	320	288	352	Drawing oils, gear oils
460	460	414	506	
680	680	612	748	Gear oils
1000	1000	900	1100	
1500	1500	1350	1650	-
2200	2200	1980	2420	
3200	3200	2880	3520	

Classification according to DIN ISO 3448

## Miscibility of Base Oils

BASE OIL	Mineral oil	Polyalphaolefin	Ester	Polyglycol	Silicone oil (Methyl)
Mineral oil		●	◐	○	○
Polyalphaolefin	●		◐	○	○
Ester	◐	◐		◐	○
Polyglycol	○	○	◐		○
Silicone oil (Methyl)	○	○	○	○	
Silicone oil (Phenyl)	◐	○	◐	○	◐
Perfluoropolyether	○	○	○	○	○

## Miscibility of Thickener

THICKENER	Calcium soap	Calcium complex soap	Lithium soap	Lithium complex soap	Lithium/calcium soap
Calcium soap		◐	●	●	●
Calcium complex soap	◐		◐	●	●
Lithium soap	●	◐		●	●
Lithium complex soap	●	●	●		●
Lithium/calcium soap	●	●	●	●	
Sodium soap	◐	◐	○	○	○
Gel	●	●	●	●	●
Bentonite	◐	○	○	○	○
Barium complex soap	●	◐	●	◐	●
Aluminium complex soap	○	○	○	●	○
Polyurea	◐	●	●	●	●

Silicone oil (Phenyl)	Perfluoropolyether
●	○
○	○
●	○
○	○
●	○
	○
○	

miscible ●  
 partially miscible ●  
 non-miscible ○

Sodium soap	Gel	Bentonite	Barium complex soap	Aluminium complex soap	Polyurea
●	●	●	●	○	●
●	●	○	●	○	●
○	●	○	●	○	●
○	●	○	●	●	●
○	●	○	●	○	●
	●	●	●	○	●
●		●	●	○	●
●	●		●	○	●
●	●	●		●	●
○	○	○	●		●
●	●	●	●	●	

The above mentioned miscibilities represent general tendencies only. In each individual case the miscibility should be confirmed by the supplier or verified in laboratory tests.

## Elastomer and Plastic Compatibilities of Various Lubricants

Lubricating greases and their behaviour towards sealing materials (elastomers)

		Lubricating grease group A	Lubricating grease group B
		Mineral oils with metal soaps, poly-urea or inorganic thickeners  e.g.: Berulub FA 46 Berutemp M 21 HT BECHEM High-Lub LT 2 EP BECHEM High-Lub SW 2	Diester oils, polyglycols, poly-butenes with metal soaps or inorganic thickeners  e.g.: Berulub FK 35 B Berulub Hydrohaf 2 Berulub KR-EL 2 Berulub KR-EP 2 Beruplex LG 21 F
Abbreviation	Elastomers		
ACM	acrylate rubber	●	○
CR	chloroprene rubber	◐	○
EPDM	ethylene-propylene-diene rubber	○	◐
FKM/FPM	fluorinated rubber	●	◐
FEPM	propylene-tetrafluoroethylene rubber	●	●
HNBR	hydrogenated nitrile-butadiene rubber	●	○
NBR	nitrile-butadiene rubber	●	○
SBR	styrene-butadiene rubber	◐	○

Lubricating greases and their behaviour towards plastics (thermoplastics/thermosets)

		Lubricating grease group A	Lubricating grease group B
Abbreviation	Plastics (thermoplastics/thermosets)		
ABS	acrylonitrile-butadiene-styrene	●	◐
PA	polyamide (polycaprolactam)	●	●
PC	polycarbonate	◐	○
PC/ABS	polycarbonate/acrylonitrile-butadiene-styrene	◐	○
PE	polyethylene	●	●
PET/PBT	polyethylene terephthalate/polybutylene terephthalate	●	●
POM	polyoxymethylene, polyacetal	●	●
PP	polypropylene	●	●
PTFE	polytetrafluoroethylene	●	●
PU	polyurethane	●	●
PVC	polyvinyl chloride	●	●
TPE	thermoplastic elastomer (polyether/polyester)	◐	◐

The mentioned compatibilities are based on laboratory tests and references. In view of the variety of used raw materials as well as the complex chemical and morphological structure of the polymers the given information represent general tendencies only. In individual cases and especially prior to serial production the compatibilities should be confirmed by the supplier or verified in laboratory tests.





Product	Page	Product	Page	Product	Page	Product	Page
BECHEM Avantin 251	82	BECHEM High-Lub LT 2 EP-SEB	19	Berucoat AK 978	78	Beruforge 200 CU	103
BECHEM Avantin 255	84	BECHEM High-Lub LT 3 EP	19	Berucoat FX 270	79	Beruforge 350	103
BECHEM Avantin 255 FF	82	BECHEM High-Lub SW 2	19, 115	Berucoat FX 670	79	Beruforge 393 G	103
BECHEM Avantin 261	84	BECHEM High-Lub SW 2 Spray	72	Berucoat FX 876	79	Beruforge 2002 B	103
BECHEM Avantin 270	82	BECHEM Hydrostar 32 D	48	Berucol HM	83	Beruforge 2450 B	104
BECHEM Avantin 310	86	BECHEM Hydrostar 46 D	48	Berucut 10	87	Beruforge 5032 D	89
BECHEM Avantin 320 FF	85	BECHEM Hydrostar 68 D	48	Berucut 15	87	Beruforge KFP 10	100
BECHEM Avantin 331	85	BECHEM Hydrostar HEES 46 EEL	59	Berucut 20 ZF	90	Beruforge KFP 22	102
BECHEM Avantin 331 FF	85	BECHEM Hydrostar HEP 22	48, 59	Berucut 22	87	Beruforge KFP 22 P	102
BECHEM Avantin 338	86	BECHEM Hydrostar HEP 32	48, 59	Berucut 32	87	Beruforge KFP 49	100
BECHEM Avantin 340 FF	85	BECHEM Hydrostar HEP 46 EEL	48, 59	Berucut MQL-A 16	90	Beruforge KFP 95	100
BECHEM Avantin 341	86	BECHEM Hydrostar HY 46 Red	48	Berucut MQL-A 20	90, 94	Beruforge KFP 96	100
BECHEM Avantin 361 FF	82	BECHEM Hydrostar TE 68 S	48, 59	Berucut MQL-AP 20	90	Beruforge KFP 96 HC	101
BECHEM Avantin 361 I-N	85	BECHEM Ovitol KT 100 S	50	Berucut MQL-E 30	90	Beruforge KFP 810	102
BECHEM Avantin 400	84	BECHEM Ovitol KT 220 S	50	Berucut MQL-E 32	91	Beruforge KFP PP-Z	101
BECHEM Avantin 402	84	BECHEM Ovitol KT 460 S	50	Berucut RMO 35 ZF	89	Beruforge MF 85	101
BECHEM Avantin 405	82	BECHEM Plantfluid	60	Berucut RMO 244	89	Beruforge MF 105-100	101
BECHEM Avantin 407	85	BECHEM Premium 0	43	Berucut RMO 822-8	87	Beruforge MF 148 NEU	101
BECHEM Avantin 408 M	85	BECHEM Starlit EM-MA-DF	49, 106	Berucut RMO TC 18 Package	89	Beruforge MF 148-68	101
BECHEM Avantin 420	82	BECHEM Staroil G 100	50	Berucut RMO 35 PC	91	Beruforge MF 155	101
BECHEM Avantin 426	85	BECHEM Staroil G 150	50, 63	Berucut SCO 310	87	Beruforge MF 465	96
BECHEM Avantin 438	82	BECHEM Staroil G 220	50, 63	Berucut SCO 322	87	Beruforge MF 1136 B	101
BECHEM Avantin 451	82	BECHEM Staroil G 320	50, 64	Berucut SCO 322 HC	87	Beruforge MF 1146	101
BECHEM Avantin 455	83	BECHEM Staroil G 460	50	Berucut SCO 446 ECO	91	Beruforge MF 1167 B	102
BECHEM Avantin 3309	86	BECHEM Staroil G 680	51	Berucut SFO 7 HC	88	Beruforge MF 1356	96
BECHEM Avantin 3332	86	BECHEM Staroil HVI 46	49	Berucut SFO 205	88	Beruforge MF 148-68	101
BECHEM Avantin 4015	83	BECHEM Staroil NR 10	49	Berucut TBO 315	90	Beruforge MF 155	101
BECHEM Avantin 4409	83	BECHEM Staroil NR 22	49	Berucut TBO 315 ZF	90	Beruforge MF 465	96
BECHEM Ceritol CF 2	20	BECHEM Staroil NR 32	49	Berucut TBO 422	90	Beruforge MF 1136 B	101
BECHEM Ceritol CS 415 EP	26	BECHEM Staroil NR 46	49	Berucut TBO 622	90	Beruforge MF 1146	101
BECHEM Ceritol PK 1	30	BECHEM Staroil NR 68	49	Berucut XC 1010	88	Beruforge MF 1167 B	102
BECHEM Ceritol PK 1 Soft	30	BECHEM Staroil SMO 68	51	Berucut XC 1015	88	Beruforge MF 1356	96
BECHEM Ceritol PSA 12 H	22	BECHEM Staroil SMO 150	51	Berucut XC 1022	88	Beruforge MF 148-68	101
BECHEM Ceritol SGR 4-00-9 P	26	BECHEM Staroil SMO 220	51	Berucut XC 1110	88	Beruforge MF 155	101
BECHEM ECO Fluid CS 120	54, 59	BECHEM Staroil SMO 320	51	Berucut XC 1115	88	Beruforge MF 465	96
BECHEM Ecorail 2001 Plus	39	BECHEM Staroil SMO 460	51	Berucut XC 1122	88	Beruforge MF 1136 B	101
BECHEM Ecorail 2002	39	BECHEM Staroil SMO 680	51	Berucut XC 2005	88	Beruforge MF 1146	101
BECHEM Ecorail 2009	39	BECHEM Staroil SMO 1500	51	Berucut XC 2105	89	Beruforge MF 1167 B	102
BECHEM Ecorail 2012	39	BECHEM Unopol AL 560	98	Berucut XC 4015	89	Beruforge MF 1356	96
BECHEM Ecorail 2016	39	BECHEM Unopol AL 570	98	Berucut XC 4122	89	Beruforge MF 148-68	101
BECHEM Ecorail 5501	39	BECHEM Unopol F 811	97	Berucut XC 5022	89	Beruforge MF 155	101
BECHEM Ecorail 5502	39	BECHEM Unopol G 560	97	Berudraw 2291-1	99	Beruforge MF 465	96
BECHEM Ecorail 8000	39	BECHEM Unopol S 621	97	Berudraw 3587	99	Beruforge MF 1136 B	101
BECHEM Ecorail 8200	39	BECHEM Unopol S 643	97	Berudraw 3779	99	Beruforge MF 1146	101
BECHEM Ecorail EES 46	38	BECHEM Unopol S 803	98	Berudraw 3955	99	Beruforge MF 1167 B	102
BECHEM Fimitol P 87 AF	49	BECHEM Unopol S KF	98	Berudraw 3985	54	Beruforge MF 1356	96
BECHEM Fluid SD	60	BECHEM Unopol SP 930	98	Berudraw 4046	99	Beruforge MF 148-68	101
BECHEM Fluid W 68-3H	60	BECHEM Unopol SPG 623	98	Berudraw AL 3	98	Beruforge MF 155	101
BECHEM Fluid W 68-3H Spray	60, 72	BECHEM Unopol SV 2 KF	115	Berudraw AL 20	98	Beruforge MF 465	96
BECHEM High-Lub FA 40 MO	25	BECHEM Unopol U 570	98	Berudraw AL 105	99	Beruforge MF 1136 B	101
BECHEM High-Lub FA 50	25	Beruclean 111 EHF	110	Berudraw AL 14 V-S	99	Beruforge MF 1146	101
BECHEM High-Lub FA 50 MO	25	Beruclean 113 EMF	110	Berudraw ZD 818 NEU	99	Beruforge MF 1167 B	102
BECHEM High-Lub FA 67-2	24	Beruclean 3050	110	Berufuid AL 1004	83	Beruforge MF 1356	96
BECHEM High-Lub FA 67-220	24	Beruclean 3305	111	Berufuid AS 1006	83	Beruforge MF 148-68	101
BECHEM High-Lub FA 67-400	20, 25	Beruclean 3849	111	Berufuid AS 1008	83	Beruforge MF 155	101
BECHEM High-Lub FA 67-400 KS	24	Beruclean 5000	111	Berufuid Cut K	83	Beruforge MF 465	96
BECHEM High-Lub KLF 2 K	19	Beruclean 5005	111	Berufuid Cut 'n Grind 5	83	Beruforge MF 1136 B	101
BECHEM High-Lub L 1 EP	18	Beruclean 5100	111	Berufuid Cut 'n Grind KA	84	Beruforge MF 1146	101
BECHEM High-Lub L 2	18	Beruclean 5124	111	Berufuid Grind HM-B	84	Beruforge MF 1167 B	102
BECHEM High-Lub L 2 EP	18	Beruclean 5200	111	Berufuid NE 1003	84	Beruforge MF 1356	96
BECHEM High-Lub L 2 MO	18	Beruclean ECO	110	Berufuid ST 1003	84	Beruforge MF 148-68	101
BECHEM High-Lub L 3	18	Beruclean H1 Spray	62, 72, 110	Berufuid ST 2003	84	Beruforge MF 155	101
BECHEM High-Lub LFB 2000	19	Beruclean S 114 ECO	110	Berufuid WO	60	Beruforge MF 465	96
BECHEM High-Lub LIC-00	27	Beruclean S 214	110	Beruforge 100	102	Beruforge MF 1136 B	101
BECHEM High-Lub LIC-000	27	Beruclean S 4033	110	Beruforge 120 AL	102	Beruforge MF 1146	101
BECHEM High-Lub LM 0 EP	18	Berucoat AF 130	78	Beruforge 120 D	103	Beruforge MF 1167 B	102
BECHEM High-Lub LM 2 EP	18	Berucoat AF 291	78	Beruforge 120 DL	103	Beruforge MF 1356	96
BECHEM High-Lub LM 3 EP	18	Berucoat AF 320 E	78	Beruforge 152 D	100	Beruforge MF 148-68	101
BECHEM High-Lub LT 0 EP	26	Berucoat AF 438	78	Beruforge 152 DL	100	Beruforge MF 155	101
BECHEM High-Lub LT 1 EP	19	Berucoat AF 438 Spray	72	Beruforge 170	103	Beruforge MF 465	96
BECHEM High-Lub LT 2 EP	19, 42	Berucoat AF 481	78	Beruforge 190	103	Beruforge MF 1136 B	101
BECHEM High-Lub LT 2 EP-400	19	Berucoat AF 732	78	Beruforge 191	103	Beruforge MF 1146	101
BECHEM High-Lub LT 2 EP-H	19	Berucoat AK 376	78			Beruforge MF 1167 B	102

Product	Page	Product	Page	Product	Page
Berulit EL 420	26	Berulub PAL 1	29, 68	Berubynth CB 180 H1	56, 62
Berulit GA 400	26	Berulub PAL 3	29, 34, 68	Berubynth CB 180 H1 Spray	74
Berulit GA 800	26	Berulub PG 3 F	35	Berubynth CC 100	56
Berulit GA 800 Fluid	26	Berulub PMP 75	31	Berubynth CF 250	56
Berulit GA 2500	27	Berulub PV DAB 10	42	Berubynth CG 370 H1	56, 62
Berulit GA 2500 Fluid	27	Berulub Palfuid Spray	73	Berubynth CP 20	56
Berulit GA 2500 Spray	72	Berulub Paste PM 30	68	Berubynth CP 73	56
Berulit Gear Spray	72	Berulub Paste PT 2	68	Berubynth CP 80	56
Berulit IKP	54	Berulub Sihaf 1	34	Berubynth CP 80 Spray	74
Berulub 151 Assembly Paste	69	Berulub Sihaf 2	35, 41	Berubynth CU 46	57
Berulub 932 Antiseize Paste	40, 68	Berulub TCG 1 V	33	Berubynth CU 100	57
Berulub 52142	20, 25	Berulub VPN 13	69	Berubynth CU 250	57, 64
Berulub AF 230	79	Berulub VPN 13 Ringlub	69	Berubynth CU 250 Spray	74
Berulub CVH 170	28	Berulub VPN 13 Spray	73	Berubynth CU 3000	57
Berulub CVH 170 LF	28	Berulub W+B Spray	73	Berubynth CU 3000 Spray	74
Berulub CVN 140	28	Berulub WP 402 H1	21, 42	Berubynth CW 280	57
Berulub Copper Paste	68	Berulub XP 719	29	Berubynth EP 68	52
Berulub ECO GD 40 Spray	72	Berulub XP 746	29	Berubynth EP 100	52, 63
Berulub ECO Super 1	40	Berulub XP 3000	31	Berubynth EP 150	52, 63
Berulub ECO Super 2	40	Beruplex CS 2 EP	21	Berubynth EP 220	53
Berulub FA 37	20, 42	Beruplex CS 2-1 EP	21	Berubynth EP 320	53
Berulub FA 46	20, 42	Beruplex HTA	21, 42, 44	Berubynth EP 460	53
Berulub FB 34	20, 41	Beruplex KS 22	21	Berubynth EP 680	53
Berulub FB 34-00	27	Beruplex LG 1-30	28, 33	Berubynth EP 1000	53
Berulub FE 16	28, 33	Beruplex LG 21 F	28, 33	Berubynth GP 68	53
Berulub FG 8 EP	27	Beruplex LHC 10	32	Berubynth GP 150	53, 63-64
Berulub FG-H 2 EP	20, 31, 41	Beruplex LI-EP 2	22, 28, 43	Berubynth GP 220	53
Berulub FG-H 2 EP Spray	73	Beruplex LO 10	32	Berubynth GP 320	53
Berulub FG-H 2 SL	20, 41	Beruplex LO 21	32	Berubynth GP 460	54
Berulub FH 28	31	Beruplex PMC 40 F	24	Berubynth GP 1000	54
Berulub FH 57	30	Beruplex PMC 42 F	24	Berubynth H1 Spray	57, 62, 74
Berulub FK 33	36	Beruplex RO 2	23, 43	Berubynth PG 220 H1	62
Berulub FK 35 B	38	Beruprotect 25 S	114	Berubynth PG 460 H1	62
Berulub FK 60	37	Beruprotect 30 W	114	Berubynth PG 680 H1	62
Berulub FK 64	36	Beruprotect DW 5 V	114	Berutemp 170	23
Berulub FK 80	36	Beruprotect DW 12 V	114	Berutemp 500 G 2	22, 30, 41
Berulub FK 97 E	36	Beruprotect DW 20 M	114	Berutemp 500 T 2	22, 41
Berulub FK 122 UV	35	Beruprotect M 6	114	Berutemp A 17	22
Berulub FK 125	38	Beruprotect M 20	114	Berutemp FB 38	20, 23, 25, 43
Berulub FK 164 Dispersion OZF 10 37		Beruprotect M 40	114	Berutemp FH 28 G	23
Berulub FK 164 Dispersion OZF 20 37		Beruprotect M 50	115	Berutemp M 21 HT	21
Berulub FK 164-2 UV	29, 36	Beruprotect Rope Dressing	115	Berutemp PA 1 EP	22
Berulub FK-SU 2	36	Beruprotect Rope Spray	73	Berutemp PA 1 MO	23
Berulub FK-VPT 380	30, 36	Beruprotect Spray	73, 115	Berutemp PA 415 GR	27
Berulub FO 34	35	Beruprotect WM 190 M	115	Berutox FB 22	24, 43
Berulub FR 16	31	Beruprotect WM 3620 W	115	Berutox FB 48-1	24, 31
Berulub FR 16 B	32	Berusil CDG 352	34	Berutox FE 18 EP	24
Berulub FR 16 SC	33	Berusil FO 22 F	33	Berutox FH 28 EPK 2	22
Berulub FR 32-21	31	Berusil FO 25	35	Berutox FH 28 KN	23, 43
Berulub FR 43	32	Berusil FO 26	35	Berutox M 21 EPK	21, 29, 43
Berulub FR 43 Spray	43, 73	Berusil FO 36-2	33	Berutox M 21 EPK 420	27
Berulub FR 82	30	Berusil FO 63	41	Berutox M 21 EPK-A	29
Berulub FR 150-21	32	Berusil P 140 Spray	58, 63, 74	Berutox M 21 KN	21, 43
Berulub FR 400-21	32	Berusil SM 50	58	Berutox MB 2-H	21
Berulub FR 3000-21	32	Berusil SM 350	58	Berutox VPT 54-1	41
Berulub FU 5	34	Berusil SM 2000	58	Berutox VPT 54-2	22, 34
Berulub FZ 1 E 3	38, 69	Berusil TS 1	33	Berutox VPT 64 Dispersion OZF 0,5 37	
Berulub FZ 2 S	38, 69	Berusoft 10	32	Berutox VPT 64 Dispersion OZF 1 37	
Berulub FZ 3 HT	36, 68	Berusoft 15	31	Berutox VPT 64 Dispersion OZF 10 37	
Berulub Fluid W+B	60	Berusoft 20	31	Berutox VPT 64 Dispersion OZF 20 37	
Berulub GD 50 H1 Spray	62, 73	Berubynth 15 H1	54, 60	Berutox VPT 64 Dispersion OZF 25 37	
Berulub Hydrohaf 2	34	Berubynth 32 H1	55, 60	Berutox VPT 64 Dispersion OZF 5 37	
Berulub KR-EL 2	38	Berubynth 46 H1	55, 61	Berutox VPT 64-2	22
Berulub KR-EP 2	24	Berubynth 68 H1	55, 61	Kubitrac 2508 EB	105
Berulub LE 1 X	40	Berubynth 100 H1	55, 61	Masterdraw 558 SC	106
Berulub LHC 2 M	30	Berubynth 150 H1	55, 61	Masterdraw 560	105
Berulub MG Paste	68	Berubynth 220 H1	55, 61	Masterdraw EBE 110	105
Berulub ND Spray	73	Berubynth 320 H1	55, 61	Masterdraw EBE 270	106
Berulub ND-Dispersion 10	30, 36	Berubynth 460 H1	55, 61	Masterdraw EBE 430	106
Berulub ND-Fluid 160	29	Berubynth 680 H1	55, 61		
Berulub Nickel Paste	69	Berubynth 1000 H1	56, 61		
Berulub OX 40 EP	34	Berubynth 1000 H1 Spray	62, 74		
Berulub OX 100 EP	34	Berubynth CA 100	56		

<b>A</b>	<b>Acrylate rubber (ACM)</b> .....	Polymer with elastomeric properties for ethyl acrylate or copolymer with additional monomers, e.g. ethylene (ethene)
	<b>Acrylonitrile butadiene styrene (ABS)</b> .....	Thermoplastic polymer, produced from three different monomers
	<b>ACS</b> .....	Attestation de conformité sanitaire: French approval for products to be used in contact with drinking water
	<b>Active sulfur compound</b> .....	Sulfur containing chemical compound, which reacts at temperatures of +100 °C or lower with copper forming copper sulfide
	<b>Aluminium complex soap</b> .....	Mixture of different, in most cases organic acids, saponified with aluminium hydroxide
	<b>AN</b> .....	Classification letters for standard lubricating oils according to DIN 51502
	<b>Anti wear properties (AW)</b> .....	Property to reduce abrasive wear by formation of a reaction layer on the surface of the friction partners under pressure and temperature
<b>B</b>	<b>BAM inspection</b> .....	Gaseous oxygen impact test (pneumatic impact test) by the German Federal Institute for Materials Research and Testing (BAM: Bundesanstalt für Materialforschung und -prüfung)
	<b>Barium complex soap</b> .....	Mixture of different, in the majority of cases organic acids, saponified with barium hydroxide
	<b>Base oil</b> .....	Main component of oil containing lubricants, in most cases mineral oil, but also polyalphaolefin, ester, polyglycol etc.
	<b>Belgaqua certificate</b> .....	Certificate of the Belgian Federation for the Water Sector for products in contact with drinking water
	<b>Bentonite</b> .....	Swellable siliceous mineral with layer structure, used as thickener for greases
	<b>Biostability</b> .....	Property to resist microbial degradation
	<b>Breakaway torque</b> .....	Moment (force) occurring at the transition from static friction to rolling or sliding friction
<b>C</b>	<b>Calcium complex soap</b> .....	Mixture of different, in the majority of cases organic acids, saponified with calcium hydroxide
	<b>Calcium soap</b> .....	Organic acid (mostly fatty acid), saponified with calcium hydroxide
	<b>CEC test</b> .....	Eldest test method to confirm ready biodegradability
	<b>CGLP</b> .....	Classification letters for slideway oil according to DIN 51502
	<b>Chemically inert</b> .....	Property, not to react chemically with other substances or compounds
	<b>Chlorine free</b> .....	Absence of chlorine containing additives
	<b>Chloroprene rubber</b> .....	Chlorine containing elastomer, generated by polymerisation of 2-chloro-1,3-butadiene
	<b>CL</b> .....	Classification letters for gear oil according to DIN 51517-2 containing antioxidants and anti-corrosion additives
	<b>CLP</b> .....	Classification letters for gear oil according to DIN 51517-3 containing anti corrosion additives, antioxidants and additives to reduce friction and wear
	<b>Coatings</b> .....	Covering layer, which is applied to a substrate
	<b>Cold welding</b> .....	Welding of metallic friction partners at room temperature, supported by high contact area and contact pressure
	<b>Consistency temperature behaviour</b> .....	Characterisation of the relationship between temperature and consistency of greases and pastes
	<b>Contact pressure</b> .....	Force per area in the contact of the friction partners

<b>Creep properties</b> .....	Capability of lubricants to penetrate cracks, gaps and fittings
<b>D</b>	
<b>Damping grease (Noise damping grease)</b> .....	Grease for reducing noise and vibrations
<b>Detergent</b> .....	Cleaning
<b>Dielectric behaviour</b> .....	Electrically non-conductive
<b>DIN EN 377</b> .....	Standard for greases to be used in non-industrial fuel gas systems
<b>DIN ISO 15380</b> .....	Standard with minimum requirements for environmentally friendly hydraulic fluids, largely complying with VDMA 24568
<b>DIN-DVGW approval mark</b> .....	Certificate of the German Technical and Scientific Association for Gas and Water
<b>Disperse</b> .....	Mixing (or mixture) of insoluble substances into each other
<b>Dropping point</b> .....	Temperature, at which a grease thickener starts to melt or degrade
<b>E</b>	
<b>E</b> .....	Classification letter for ester based lubricants according to DIN 51502, e.g. used as CLP E
<b>EC aluminium</b> .....	Aluminium for applications as electrical conductor
<b>Eco Label</b> .....	European certification and label for products with environmental advantages
<b>Ester</b> .....	Chemical compound, derived from chemical reaction between alcohols and acids under release of water
<b>Ethylene propylene diene rubber (EPDM)</b> ..	Elastomeric polymer, at a percentage of ethylene of 65% or higher with thermoplastic properties
<b>Extreme pressure properties (EP)</b> .....	Property of a lubricant to provide a high load carrying capacity by formation of a reaction layer on the surface of the friction partners under pressure and temperature
<b>F</b>	
<b>F</b> .....	Classification letter according to DIN 51502 for lubricants containing solid lubricants
<b>Fluorinated rubber (FPM: DIN-ISO/FKM: ASTM)</b> .....	Collective name for fluorinated polymers with elastomeric properties
<b>Fogging behaviour</b> .....	Analysis of the emission behaviour, tendency of a product to release substances into the ambient air
<b>Fretting corrosion</b> .....	Corrosion phenomenon (tribocorrosion), which occurs in tribosystems with oscillating loads
<b>Friction coefficient</b> .....	Quotient of friction force and normal force, low friction coefficient = low friction
<b>Friction force</b> .....	Force, generated by the contact of two friction partners in relative motion in opposite direction to the driving force
<b>Friction torque</b> .....	In rotational systems equivalent to the friction force
<b>Fully synthetic</b> .....	Without using mineral oil in the lubricant formulation
<b>G</b>	
<b>Gel</b> .....	System of a solid substance, which is finely dispersed in a liquid, forming a sponge-like structure
<b>Graphite</b> .....	Stable form of the chemical element carbon with layer structure, used as solid lubricant
<b>H</b>	
<b>H1</b> .....	Identification of food grade lubricants, i. e. lubricants which can be applied where incidental food contact cannot be excluded
<b>H2</b> .....	Identification of lubricants for the general use in the food processing industry, provided food contact is excluded

<b>Halal certificate</b> .....	Certificate of approval for products, which can be designated as “permitted” or “acceptable” according to Islamic law
<b>Hard water stability</b> .....	Property to form stable emulsions, solutions and dispersions in hard water and to prevent the formation of deposits with hard water
<b>HC</b> .....	Classification letters for polyalphaolefin based lubricants according to DIN 51502, e.g. used as CLP HC
<b>HEES</b> .....	Classification letters according to DIN 51502 for synthetic ester based hydraulic fluids
<b>HETG</b> .....	Classification letters according to DIN 51502 for triglyceride based (native ester based) hydraulic fluids
<b>HFA</b> .....	Classification letters according to DIN 51502 for fire resistant hydraulic fluids type A: HFAE – oil in water emulsions, HFAS – aqueous solutions
<b>HFC</b> .....	Classification letters according to DIN 51502 for fire resistant hydraulic fluids type C: aqueous polymer solution (water glycol)
<b>HFDU</b> .....	Classification letters according to DIN 51502 for fire resistant hydraulic fluids type D: fluids free of water, subgroup U-ester based
<b>HL</b> .....	Classification letters for hydraulic oils according to DIN 51524-1, containing antioxidants and anti corrosion additives
<b>HLP</b> .....	Classification letters for hydraulic oils according to DIN 51524-2, containing antioxidants, anti-corrosion additives and additives to reduce friction and wear
<b>HLPD</b> .....	Classification letters according to DIN 51502 for hydraulic oils with detergent properties
<b>HVLP</b> .....	Classification letters for hydraulic oils with high viscosity index (min. 140) according to DIN 51524-3, containing antioxidants, anti corrosion additives and additives to reduce friction and wear
<b>Hybrid technology</b> .....	Product, derived from the combination of different technologies
<b>Hydrogenated nitrile butadiene rubber (HNBR)</b> .....	Elastomer, generated by polymerisation of acrylonitrile and butadiene and a following treatment with hydrogen
<b>I</b> <b>Inhibited against yellow metals corrosion</b> .....	Lubricants with additives against yellow metals corrosion
<b>Inorganic binder</b> .....	Binding agent in coatings, based on inorganic chemical compounds
<b>L</b> <b>Lithium complex soap</b> .....	Mixture of different, in most cases organic acids, saponified with lithium hydroxide
<b>Lithium/calcium soap</b> .....	Organic acid (mostly fatty acid), saponified with lithium hydroxide and calcium hydroxide
<b>Lithium soap</b> .....	Organic acid (mostly fatty acid), saponified with lithium hydroxide
<b>M</b> <b>Medical white oil</b> .....	By treatment with hydrogen highly refined mineral oil with extremely low content of aromatic hydrocarbons, suitable for pharmaceutical applications
<b>Micropitting load carrying capacity</b> .....	Property to prevent micropitting (grey staining) in gears
<b>Molybdenum disulfide (MoS<sub>2</sub>)</b> .....	Inorganic solid lubricant with layer structure
<b>Multifunctional oils</b> .....	Lubricating oils for multiple applications, e.g. as hydraulic fluid, slideway oil and cold forming oil
<b>N</b> <b>Native ester</b> .....	Chemically unmodified oil from vegetable or animal sources, in most cases triglycerides (ester with glycerol as alcohol component)
<b>Nitrile butadiene rubber (NBR)</b> .....	Elastomer, generated by polymerisation of acrylonitrile and butadiene
<b>NLGI-grade</b> .....	Consistency of greases and pastes according to a classification of the American National Lubricating Grease Institute
<b>Noise damping value</b> .....	BEICHEM classification of noise damping to prevent background noise from car interior components (low: against slight, medium: against medium, high: against heavy squeak and rattle noises)

<b>Non-ferrous metals</b>	All metals apart from iron and its alloys, sometimes colloquially used for yellow metals
<b>O</b> <b>OECD 301</b>	Today's common test methods to prove ready biodegradability, several procedures available (A - F) depending on tested substance properties and detection method
<b>Organic binder</b>	Binding agent in coatings, based on organic chemical compounds
<b>Organic polymer</b>	Macromolecules, generated by polymerisation of organic monomers
<b>P</b> <b>PA</b>	Polycaprolactame, thermoplastic polymer, belonging to the group of polyamides
<b>PD additives</b>	Additives, which smooth the surface roughness of friction partners by plastic deformation
<b>Perfluoropolyether (PFPE)</b>	Fully fluorinated polyethers: polymeric lubricating oils with outstanding temperature stability and plastic compatibility
<b>PG</b>	Classification letters for polyglycol based lubricants according to DIN 51502, e.g. used as CLP PG
<b>Phosphorus compounds</b>	Additives containing phosphorus as a component of the molecule
<b>Polar additives</b>	Additives forming a lubricating film by physisorption (adsorption without chemical reaction)
<b>Polyalphaolefin (PAO)</b>	Synthetic hydrocarbon, generated by polymerisation of alphaolefines
<b>Polyamide (PA)</b>	Thermoplastic polymer, formed by polycondensation from amino carboxylic acids or lactames or dicarboxylic acids with diamines or amino carboxylic acids
<b>Polycarbonate (PC)</b>	Thermoplastic polymer belonging to the group of polyesters
<b>Polyethylene (PE)</b>	Thermoplastic polymer, generated by polymerisation of ethylene (ethen)
<b>Polyethylene/polybutylene terephthalate (PET/PBT)</b>	Thermoplastic polymer belonging to the group of polyesters
<b>Polyglycol (PG)</b>	Polymer (polyether), generated by polymerisation of ethylene oxide and/or propylene oxide, in use as lubricant base oil or additive
<b>Polyoxymethylene, Polyacetal (POM)</b>	Thermoplastic polymer, generated by polymerisation of formaldehyde
<b>Polypropylene (PP)</b>	Thermoplastic polymer, generated by polymerisation of propylene (propene)
<b>Polytetrafluoroethylene (PTFE)</b>	Thermoplastic fully fluorinated polymer, in use as solid lubricant and thickener for greases
<b>Polyurea</b>	Organic polymer, generated by polyaddition from isocyanates and amines, in use as thickener for greases
<b>Polyurethane (PU)</b>	Organic polymer, generated by polyaddition of isocyanates and alcohols, in use as organic binder in coatings
<b>Polyvinylchloride (PVC)</b>	Thermoplastic, chlorine containing polymer, generated by polymerisation of vinyl chloride
<b>Pour point</b>	Lowest temperature, at which a liquid lubricant or base oil is still flowable
<b>Propylene tetrafluoroethylene rubber (FEPM)</b>	Partly fluorinated elastomer, copolymer from propylene (propene) and tetrafluoroethylene (tetrafluoroethene)
<b>S</b> <b>SEB</b>	"Stahl-Eisen-Betriebsblatt", technical guidelines from the German Steel Institute (VDEh)
<b>SEB 181 253</b>	Technical guidelines and requirements for lubricating greases of the German Steel Institute (VDEh)
<b>Semi-synthetic</b>	Using a reduced mineral oil content in the lubricant formulation

<b>SI</b> .....	Classification letters for silicone oil based lubricants according to DIN 51502, e.g. used as CLP SI
<b>Silicone oil (Methyl)</b> .....	Polydimethylsiloxane, synthetic organosilicon oil
<b>Silicone oil (Phenyl)</b> .....	Polydiphenylsiloxane, synthetic organosilicon oil
<b>Sodium soap</b> .....	Organic acid (mostly fatty acid), saponified with sodium hydroxide
<b>Solid lubricants (SL)</b> .....	Solid substances, which reduce friction by their chemical structure or by surface reaction
<b>Stick-slip</b> .....	Undesired inconstant sliding motion with continuous stop and go
<b>Styrene butadiene rubber (SBR)</b> .....	Elastomer, generated by polymerisation of styrene with butadiene
<b>Sulfur additives</b> .....	Additives containing sulfur as a component of the molecule, in use as EP or AW additives
<b>T</b> <b>Tackifier</b> .....	Additives to improve the adhesion of lubricants on surfaces
<b>Thermoplastic elastomer (TPE)</b> .....	Polymer with elastomeric properties at room temperature, capable of plastic deformation at elevated temperature
<b>Thickener</b> .....	Additive to generate and adjust the consistency of greases and pastes
<b>TPE</b> .....	Thermoplastic elastomer from polyether/polyester
<b>Tribocorrosion</b> .....	Corrosion phenomenon (fretting corrosion), which occurs in tribosystems with oscillating loads
<b>U</b> <b>UBA guideline (KTW)</b> .....	Guideline of the German Federal Environment Agency for hygiene assessment of organic materials in contact with drinking water
<b>UV tracer</b> .....	In daylight condition invisible dye, only becoming visible under UV light to check the lubricant application on parts and components
<b>V</b> <b>VDMA 24568</b> .....	Standard by the German Engineering Federation (VDMA) with minimum requirements for environmentally friendly hydraulic fluids
<b>VG grade</b> .....	Classification of liquid lubricants and base oils based on their kinematic viscosity at +40 °C according to ISO 3448
<b>Viscosity</b> .....	Reciprocal value of fluidity, internal friction of a fluid or gas
<b>Viscosity index (VI)</b> .....	Characterisation of the relationship between temperature and viscosity, a high VI oil shows a smaller change in viscosity at a given temperature shift than a low VI oil
<b>W</b> <b>Water glycol</b> .....	Colloquial term for fire resistant hydraulic fluids type C: HFC
<b>Wetting ability</b> .....	Property to spread a liquid properly on a surface
<b>White oil</b> .....	By treatment with hydrogen highly refined mineral oil with extremely low content of aromatic hydrocarbons
<b>WRAS (British Standard)</b> .....	Water Regulation Advisory Scheme: British approval procedure for products to be used in contact with drinking water
<b>Yellow metals</b> .....	Ignoble non-ferrous heavy metals: copper, cobalt, nickel, tin, zinc, cadmium, lead as well as some of their alloys (brass, bronze)
<b>3</b> <b>3H</b> .....	Identification of release agents which are used in food production to prevent adhesion of food stuffs (direct food contact is allowed)



Keyword	Page
Anti-friction coatings	78–79
Automotive industry	28–33, 35–38, 78–79
Bending	94–97
Berulfluid (Coolants)	82–84
Boron-containing, water miscible coolants	85–86
Boron-free, water miscible coolants	82–85
Broaching	89
Buffer plate greases	38–39
Central lubrication systems	18–27, 40
Chain oils	54–57
Chassis and drive systems	28
Circulation lubrication	50–54
Cleaning agents	110–111
Coating lubricants	102–105
Cold forming oils	100–102
Coolants	80–91
Corrosion protection	112–115
Cutting	87–89
Deep drawing	94–97, 99–100
Deep drilling	90
Dewatering fluid	114
Drilling	80–91
Electrical contact lubricants	35–38
Environmentally friendly lubricants	40, 59
EP-greases	18–27
Fine blanking	94–97, 100–102
Fire resistant (hydraulic fluid)	48–49
Fitting lubricants	34–35
Food grade lubricants	40–42
Forging /Massive forming	102–105
Forming	92–106
Gear lubricants	26–27, 50–54
Grinding	87–89
H1, H2, 3H	40–42
Halal	40–42
Heat sink pastes	35–38, 68–69
Heavy industry	18–27, 48–49

Keyword	Page
High-speed lubricants	24
High-temperature lubricants	21–23
Honing	80–91
Hydraulic fluids	48–49
Kosher	40–42
Low-temperature lubricants	24–25
Lubricating greases	16–44
Lubricating oils	46–64
Machine and circulation oils	50–54
Metal removal operations	80–91
Milling	80–91
Minimum quantity lubricants	90–91
Non water miscible coolants	87–91
Pastes	68–69
Plain bearings	18–25
Plastic lubrication	29–33, 35–38, 58
Punching	94–97, 100–102
Rail lubricants	38–39
Railway switch lubricants	38–39
Roller bearings	18–25
Rust remover	72–74
Sawing	87–91
Semi-fluid grease	26–27, 40
Sheet forming	94–97
Silicone oils	58
Sprays	72–74
Textile industry	42–44, 63–64
Tube drawing	105–106
Turning	80–91
Universal, multipurpose and long-life greases	18–21
UV tracer	29–33, 35–38
Water miscible coolants	82–86
Wheel flange lubricants	38–39
Wire drawing	97–100



**CARL BECHEM GMBH**

Weststraße 120  
58089 Hagen  
Germany

Phone +49 2331 935-0  
Fax +49 2331 935-1199

E-Mail: [bechem@bechem.de](mailto:bechem@bechem.de)  
[www.bechem.com](http://www.bechem.com)

Certified according to  
IATF 16949, DIN EN ISO 9001

The information contained in this catalogue is for general information purposes only. In no event will we be liable for any damage arising from the use of this catalogue. Our qualified personnel will be pleased to assist you.

Modifications and errors reserved.

© 2018 CARL BECHEM GMBH

All rights reserved. All texts, photos, graphics or other pictures shown in this catalogue are protected by the copyright law. Duplication, distribution, or any form of commercialization to third parties of such material shall require the prior written consent of the CARL BECHEM GMBH. Some pages contain information that are protected by third-party copyright.



---

**CARL BECHEM GMBH**

Weststraße 120  
58089 Hagen  
Germany  
Phone: +49 2331 935-0  
bechem@bechem.de

---

**CARL BECHEM France Sàrl**

13, Avenue de l'Europe  
67300 Strasbourg-Schiltigheim  
France  
Phone: +33 3 90208421  
bechem@bechem.fr

---

**CARL BECHEM Switzerland AG**

Wagenhauserstrasse 20  
8260 Stein am Rhein  
Switzerland  
Phone: +41 52 74202-52  
info@bechem.ch

---

**CARL BECHEM Scandinavia AB**

Hammargatan 11  
352 46 Växjö  
Sweden  
Phone: +46 470 329400  
post@bechem.eu

---

**BECHEM COGELSA Iberia S.L.**

C/ Comercio 36, P. I. Can Sunyer  
08740 Sant Andreu de la Barca  
Barcelona  
Spain  
Phone: +34 93 6822220  
info@bechem-cogelsa.com

---

**CARL BECHEM MÉXICO****Lubrication Technology****S. de R.L. de C.V.**

Prol. Bernardo Quintana Sur No. 302  
Col. Centro Sur, CP 76090 Querétaro  
Mexico  
Phone: +52 442 478 4139  
bechem@bechem.mx

---

**CARL BECHEM Africa (PTY) Ltd.**

8 Chrome Street  
1910 Vanderbijlpark, Gauteng  
South Africa  
Phone: +27 16 9811016/7  
bechem@bechem.co.za

---

**BECHEM Lubrication****Technology, LLC**

8401 Chagrin Road, Suite 5A  
Chagrin Falls, Ohio 44023  
USA  
Phone: +1 440 5616001  
america@bechem.com

---

**CARL BECHEM Lubricants (India)****Private Limited**

#28D, Bidadi Industrial Area  
Bidadi – Harohalli Main Road  
Ramanagara, Bengaluru 562109  
India  
Phone: +91 80 66900800  
info@bechemindia.com

---

**CARL BECHEM Lubricants****(Liaoning) Co., Ltd.**

No. 3 Binhe Industrial Area  
117004 Benxi, Liaoning  
China  
Phone: +86 24 45859400  
bechem@bechemchina.com

---

**CARL BECHEM Ultra-Lub****Chemicals (Zhongshan) Co., Ltd.**

No.18. Chongzhan Road,  
Shalang West District, Zhongshan  
City,528411 Guangdong  
China  
Phone: +86 760 88550808  
l830120@ms10.hinet.net

---

**BECHEM Lubrication Technology****(Shanghai) Co., Ltd.**

43/F., Maxdo Centre, 8 Xingyi Road  
Changning District, Shanghai  
China  
Phone: +86 (21) 2231 3063  
sun@bechem.com.cn

---

**CARL BECHEM GMBH Russia****and CIS Representative Office**

Komsomolskaya Ulitsa, 1  
142100 Podolsk, Moscow Region  
Russian Federation  
Phone: +7 926 7630000  
lashkov@bechem.ru



## Erratum

Due to a technical error in prepress, the chapter „Cooling lubricants for metal cutting“ (pages 82-91) unfortunately contains incorrect information in the columns „Amine free“ and „Performance additives“. To a large extent, you can also view the information on performance additives/lubricant performance and amine content on our homepage and refer to the current technical data sheets. If you have any questions, please contact your BECHEM sales partner.

The cleaner Beruclean 5005 on page 111 is only suitable for steel and grey cast iron and not for non-ferrous metals and aluminium.

Please excuse these errors and understand that the catalogue does not replace advice by our technical sales staff and that we are not liable for any damage arising from the use of the information contained in the catalogue.